

# ICX

THE FAIR  
PREMIUM  
IMPLANT-  
SYSTEM.

April\_2024\_EN

## ICX-PRODUCT CATALOGUE

ICX IMPLANTS - ICX SURGERY - ICX PROSTHETICS

04/2024



SUCCESSFUL & FAIR IMPLANTATION!

*ICX makes  
you smile!*

BE SMART. BE GUIDED. BE ICX.

**medentis**  
medical



# ICX



## ICX-PRODUCT CATALOGUE

04/ 2024

**medentis**<sup>®</sup>  
medical

ICX-SHOP!



**BE SMART. BE ICX.**



## **SERVICE**

---

Explanation of names, marks and labeling .....	6
--	---

## **SURGERY**

---

### **ICX-IMPLANTS & DRILLS**

ICX-MINI Ø 2,9mm Implants & Prosthetics .....	8/9
ICX-Ø 3,3mm (BL+TL) Implants & Prosthetics .....	10-25
ICX-PREMIUM Bone Level BL-Implants .....	26
ICX-PREMIUM TISSUE LEVEL (TL) Implants .....	27
ICX-PREMIUM Single-Implants .....	28
ICX-ACTIVE-MASTER BL-Implants.....	29
ICX-ACTIVE-MASTER Single-Implants .....	30
ICX-ACTIVE-MASTER TISSUE LEVEL (TL) Implants .....	31
ICX-ACTIVE LIQUID Implants .....	32
ICX-DIAMOND BL/TL LIQUID Implants <b>NEW +++ NEW</b> .....	34/35
ICX-ACTIVE-WHITE-Ceramic-Implants .....	36
ICX-PREMIUM Parallel and stop drills.....	38
ICX-ACTIVE-MASTER Parallel and stop drills & surgical box .....	39
ICX-ALL-IN-ONE drills <b>NEW +++ NEW</b> .....	40/41

### **ICX-DRILL STOP SLEEVES**

Overview ICX drill stop sleeves .....	42
ICX Drill Stop Sleeve Box / ICX Bonespreader Box .....	43

## **HEALING CAPS & TRANSFER**

---

### **ICX-HEALING CAPS**

Overview of ICX closure screws and healing caps/gingiva former.....	44
Overview ICX and ICX-TL healing abutments customizable/ICX bone ring set.....	45
Overview ICX Tissue Level (TL) Healing Caps .....	46

### **CERICX-HEALING CAPS**

CERICX Healing Caps & Impression Posts.....	47
---	----

### **ICX-IMPRESSION POSTS**

Overview ICX impression posts.....	48
------------------------------------	----

### **ICX MODEL ANALOG**

Overview ICX model analogs .....	49
----------------------------------	----

## PROSTHETICS

---

### 1. Cemented and bonded restoration

#### ICX-Abutments & ADHESIVE BASES

Overview ICX Titanium abutments.....	50-53
Overview ICX universal abutments.....	54
Overview ICX bar systems.....	55
Overview ICX (TL)-abutments.....	55
Overview ICX gold and plastic abutments.....	56
Overview ICX-CAD/CAM/adhesive base and scanbody.....	57
ICX-CEREC® adhesive bases and scan caps.....	58
ICX adhesive base for ZirkonZahn system.....	58

#### CERICX-ZIRCONIA ABUTMENTS

Overview CERICX zirconia abutments.....	60/61
---	-------

### 2. Occlusal screw-retained restoration

#### ICX-MULTI CONCEPT FOR OCCLUSAL SCREW FIXATION

Overview ICX-MULTI concept (4-ON-ICX & 6-ON-ICX).....	62-64
---	-------

### 3. Hybrid technique

#### ICX-t-bona BALL HEAD PATRICES & MATRICES

Overview ICX-t-bona ball head system.....	66
Overview of t-ecco & Dalbo®-Plus matrices for ICX.....	67

#### ICX-MAXIMUS (LOCATOR™) PATRICES & MATRICES

Overview ICX Maximus superstructures, one/two-piece.....	68/69
Overview ICX Maximus accessories.....	70/71

#### ICX-ACCESSORIES

---

ICX Referrer/Instrument Box.....	72
ICX-Try-in-Box.....	73
Overview ICX instruments, accessories.....	74-75
Product information Recommendations for torques.....	76-79
Product information ICX-BL + TL implants.....	80

#### **PLEASE NOTE! ICX connection (Internal Conical Hex)**

The frictional connection to the implant is **always** via the cone. Anything that inhibits the taper at platform level in the prosthetic restoration (GH=0mm) is **only** recommended for esthetic reasons!

# Explanation of the names, Signs and labels

Explanation of symbols/characters on labels/product labels and package inserts:



Batch number



Item number



Gamma sterilized



Use before expiration date



for single use only



Please read the instruction for use carefully



ICX products are CE marked and comply with the requirements of Medical Device Directive 93/42 EEC



Do not use, if packaging is damaged



Do not resterilize

## Meaning of colour coding for ICX drills & implants

White ○ = Ø 2,9mm

Red ● = Ø 3.75mm

Pink ● = Ø 3,3mm

Green ● = Ø 4.1mm

Yellow ● = Ø 3,45mm

Blue ● = Ø 4.8mm

Colour representations and sizes of the illustrations in this brochure are not binding!

# ICX-PROSTHETICS

ONLY TWO PROSTHETIC LINES FOR THE ENTIRE ICX SPECTRUM.



QUITE *SIMPLE.*



**DISCOVER** THE ICX DIFFERENCE.

BE SMART. BE ICX.

**medentis**<sup>®</sup>  
medical

[www.medentis.de](http://www.medentis.de)

# OVERVIEW: ICX-MINI Ø 2.9mm implants

## ICX-MINI Ø 2.9mm implants

All ICX-MINI Ø 2.9mm implants are only available in a pack of 6. It is a 2-piece and are supplied with a GH 1mm ball head.

ICX-MINI implant white, Ø 2.9mm

Article-No.

C-001-290080	ICX-MINI ø 2.9 x 8mm (pack of 6)
C-001-290100	ICX-MINI ø 2.9 x 10mm (pack of 6)
C-001-290125	ICX-MINI ø 2.9 x 12.5mm (pack of 6)

**Note: Only use C-003-000004 ICX-mini cover screw!**

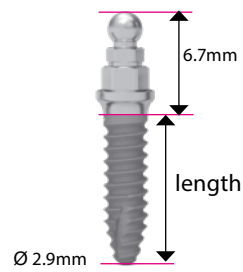

Insertion tool: C-015-100006

Insertion



Ball head removal:

Counter instrument: C-015-100009



Insertion tool: C-015-100007

Ball head



Hex tool: 960002

Cover screw

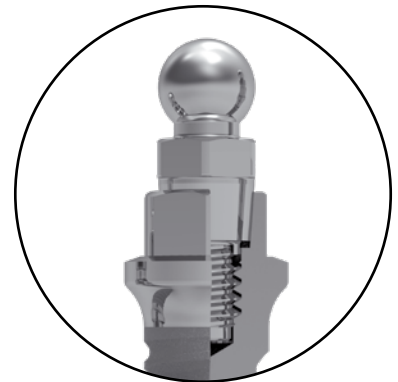







**medentis**  
medical





# OVERVIEW: ICX-MINI Ø 2.9mm prosthetics

## Overview/Prosthetics: MINI-implant ICX-MINI Ø 2.9mm

Article-No.		Article	Dimensions	Material
C-003-000004		ICX-MINI cover screw, (see note 1 below!) Is screwed in with: Art.-No.: 96 0002	-	Titanium
960002		ICX hexagonal instrument (ISO shank) SW 0,9mm, L 20mm for t-ecco inner die and ICX-mini locking cap	-	Stainless steel
C-015-100029		ICX hexagonal instrument (one-piece) SW 0,9mm, L 38,5mm for t-ecco inner die and ICX-mini locking cap	-	Stainless steel
C-022-090001		t-bona ball head mini, ball ø 2.25mm, incl. model analog	GH 1mm	Titanium
C-022-090002		t-bona ball head mini, ball ø 2.25mm, incl. model analog	GH 2mm	Titanium
C-022-090003		t-bona ball head mini, ball ø 2.25mm, incl. model analog	GH 3mm	Titanium
C-015-100007		ICX-t-bona ball head Insertion tool	L 19mm	Stainless steel

Article-No.		Article	Material
C-031-030001		ICX-Maximus for ICX-MINI, consisting of sleeve GH 3mm and base screw	Titanium

C-015-100018		Triangular turning tool 25mm (short)	Stainless steel
C-015-100031		Triangular turning tool 30mm (long)	Stainless steel

### Important note:

**ICX SPHERICAL HEAD MATRIX SYSTEM AND ICX MAXIMUS MATRIX SYSTEM  
SEE PAGES 18/19.**

Article-No.		Article	Dimensions	Material
C-026-010501		ICX-MINI massive abutment (The solid abutment coping is cemented in the patient's mouth. This subsequent solid abutment can be milled and conventionally impression). Only in combination with the ball head abutment GH 1mm.	Ø 5mm K 7mm	Titanium

# OVERVIEW - SURGERY ICX-Ø3,3mm: ICX-Ø 3.3mm BL & TL implants

## ICX-PREMIUM Ø 3.3mm implants (BL)

All ICX-PREMIUM Ø 3.3mm implants are only available in a pack of 6

Article-No.

C-001-330080	ICX-PREMIUM Ø 3.3 · L 8mm (Pack of 6)
C-001-330100	ICX-PREMIUM Ø 3.3 · L 10mm (Pack of 6)
C-001-330125	ICX-PREMIUM Ø 3.3 · L 12.5mm (Pack of 6)

Ø 3,3mm



## ICX-ACTIVE-MASTER Ø 3.3mm implants (BL)

All ICX-ACTIVE MASTER Ø 3.3mm implants are only available in a pack of 6

Article-No.

ACM-001-330080	ICX-ACTIVE-MASTER Ø 3.3 · L 8mm (Pack of 6)
ACM-001-330100	ICX-ACTIVE-MASTER Ø 3.3 · L 10mm (Pack of 6)
ACM-001-330125	ICX-ACTIVE-MASTER Ø 3.3 · L 12.5mm (Pack of 6)

Ø 3,3mm

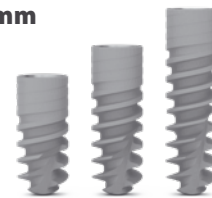

## ICX-PREMIUM Ø 3.3mm implants (TL)

All ICX-ACTIVE MASTER Ø 3.3mm implants are only available in a pack of 6

Article-No.

T-001-330080	ICX Premium TissueLine Implant Ø 3.3 x 8mm (Pack of 6)
T-001-330100	ICX Premium TissueLine Implant Ø 3.3 x 10mm (Pack of 6)
T-001-330125	ICX Premium TissueLine Implant Ø 3.3 x 12.5mm (Pack of 6)

Ø 3.3mm

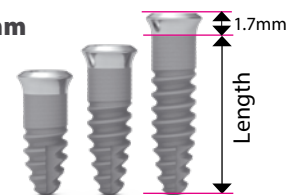

## ICX-ACTIVE-MASTER Ø 3.3mm implants (TL)

All ICX-ACTIVE MASTER Ø 3.3mm implants are only available in a pack of 6

Article-No.

TAM-001-330080	ICX Active Master TissueLine Implant Ø 3.3 x 8mm (Pack of 6)
TAM-001-330100	ICX Active Master TissueLine Implant Ø 3.3 x 10mm (Pack of 6)
TAM-001-330125	ICX Active Master TissueLine Implant Ø 3.3 x 12.5mm (Pack of 6)

Ø 3.3mm

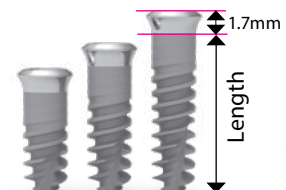

# OVERVIEW - SURGERY ICX-Ø3,3mm: ICX-Ø 3.3mm BL Single implants

## ICX-PREMIUM Ø 3,3mm Single implants (BL)

Artikel-Nr.

S-001-330080	ICX-PREMIUM Ø 3.3 · L 8mm
S-001-330100	ICX-PREMIUM Ø 3.3 · L 10mm
S-001-330125	ICX-PREMIUM Ø 3.3 · L 12.5mm

Ø 3,3mm



## ICX-ACTIVE-MASTER Ø 3,3mm Single implants (BL)

Artikel-Nr.

S-ACM-001-330080	ICX-ACTIVE-MASTER Ø 3.3 · L 8mm
S-ACM-001-330100	ICX-ACTIVE-MASTER Ø 3.3 · L 10mm
S-ACM-001-330125	ICX-ACTIVE-MASTER Ø 3.3 · L 12.5mm

Ø 3,3mm

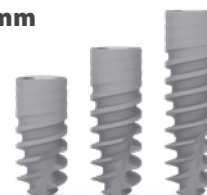

ICX-SHOP!



**BE SMART. BE ICX.**



# OVERVIEW - SURGERY ICX-Ø3.3mm: ICX-Ø 3.3mm BL & TL drills

## ICX-PREMIUM Ø 3.3mm drills

Article-No.	ICX-PREMIUM Ø 3.3 drills	Article
C-014-003330		ICX-PREMIUM Parallel drill <b>soft Ø 3.3 pink I</b> ●
C-014-006330		ICX-PREMIUM Parallel drill <b>standard Ø 3.3 pink II</b> ●
C-014-007330		ICX-PREMIUM Parallel drill <b>hard Ø 3.3 pink III</b> ●
C-014-005330		ICX-PREMIUM STOP drill <b>Ø 3.3 pink</b> ●

## ICX-PREMIUM Surgery-Box

Article-No.	ICX-PREMIUM Surgery Box (filled)	
C-018-100003	ICX-PREMIUM Surgery Box (filled)	

## ICX-ACTIVE-MASTER Ø 3,3mm drills

Article-No.	ICX-ACTIVE-MASTER Ø 3.3 drills	Article
ACM-014-003330		ICX-ACTIVE-MASTER Parallel drill <b>soft Ø 3.3 pink I</b> ●
ACM-014-006330		ICX-ACTIVE-MASTER Parallel drill <b>standard Ø 3.3 pink II</b> ●
ACM-014-007330		ICX-ACTIVE-MASTER Parallel drill <b>hard Ø 3.3 pink III</b> ●
ACM-014-005330		ICX-ACTIVE-MASTER STOP drill <b>Ø 3.3 pink</b> ●

## ICX-ACTIVE-MASTER Surgery-Box

Article-No.	ICX-ACTIVE-MASTER Surgery Box (filled)	
ACM-018-000006	ICX-ACTIVE-MASTER Surgery Box (filled)	

# OVERVIEW - SURGERY ICX-Ø3.3mm: ICX-Ø 3.3mm drill bit



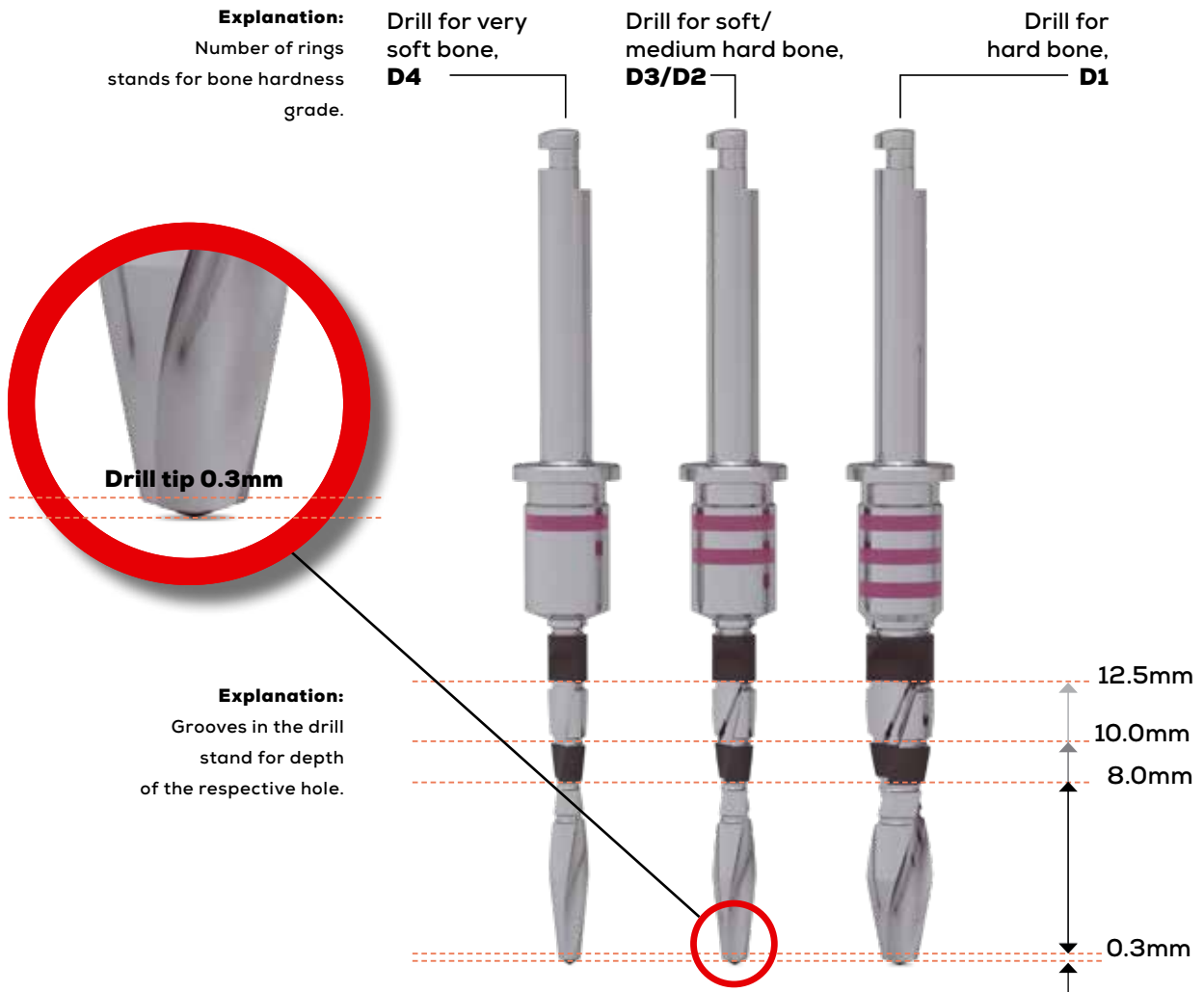

**ATTENTION! ++ IMPORTANT NOTICE ++ ATTENTION!**



With the ICX-Ø3.3mm drills, the drill length is 0.3mm longer due to the drill tip 0.3mm longer - It must be ensured, that this additional length is permissible, when working in the area of important anatomical structures.



## Insertion tools





Article no.	Article	Dimensions	Material	
N-015-100002	ICX Ø 3.3 Insertion instrument medium, ISO shaft	L = 28.5mm	Stainless steel	
N-015-100040	ICX Ø 3.3 insertion instrument locked holding function, medium, ISO shaft	L = 28.5mm	Stainless steel	
N-015-100039	ICX Ø 3.3 insertion instrument locked holding function, short, ISO shaft	L = 24mm	Stainless steel	
N-015-110000	ICX-3.3 Insertion instrument screwable		Stainless steel	

## ICX boneprofiler for ICX 3.3 BL implants with ISO-Shaft connection



Article no.	Article	Dimensions	Material	
C-014-006003	ICX boneprofiler for ICX 3.3 BL implants with ISO shaft connection  for uncovering overgrown implant platforms	L = 28mm	Stainless steel	

**Important note: Only to be used for ICX-3.3 implants!**

## Screwdriver

Article no.	Article	Dimensions	Material	
C-015-100033	ICX Hex Tool SW 1,2 Iso shaft	L = 25mm	Stainless steel	
C-015-100043	ICX hexagonal instrument (one-piece) SW 1.2mm, short	L = 21mm	Stainless steel	
C-015-100030	ICX Hex Tool SW 1.2, medium, one-piece	L = 27mm	Stainless steel	
C-015-100036	ICX Hex Tool SW 1.2, long, one-piece	L = 32mm	Stainless steel	

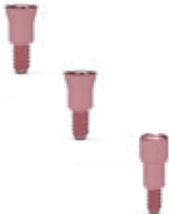

## ICX closing screws and healing caps (healing abutments)

Artikel-Nr.	Artikel	Dimensionen	Material	
N-003-000001	ICX Ø 3.3 Closing cap	GH 0mm	Titanium	
N-003-000002	ICX Ø 3.3 Closing cap <b>sterile, 6-pack</b>	GH 0mm	Titanium	
N-003-000021	ICX Ø 3.3 Closing cap <b>GH 2mm</b>	GH 2mm	Titanium	
N-004-004120	ICX Ø 3.3 Closing cap <b>conical, 2mm</b>	GH 2mm Ø 4.1	Titanium	
N-004-004130	ICX Ø 3.3 Closing cap <b>conical, 3mm</b>	GH 3mm Ø 4.1	Titanium	
N-004-004140	ICX Ø 3.3 Closing cap <b>conical, 4mm</b>	GH 5mm Ø 4.1	Titanium	
N-004-004150	ICX Ø 3.3 Closing cap <b>conical, 5mm</b>	GH 5mm Ø 4.1	Titanium	
N-004-004510	ICX Ø 3.3 Closing cap <b>conical, 1mm</b>	GH 1mm <b>Ø 4,5</b>	Titanium	
N-004-004520	ICX Ø 3.3 Closing cap <b>conical, 2mm</b>	GH 2mm <b>Ø 4,5</b>	Titanium	
N-004-004530	ICX Ø 3.3 Closing cap <b>conical, 3mm</b>	GH 3mm <b>Ø 4,5</b>	Titanium	
N-004-004540	ICX Ø 3.3 Closing cap <b>conical, 4mm</b>	GH 4mm <b>Ø 4,5</b>	Titanium	
N-004-004550	ICX Ø 3.3 Closing cap <b>conical, 5mm</b>	GH 5mm <b>Ø 4,5</b>	Titanium	
N-004-004560	ICX Ø 3.3 Closing cap <b>conical, 6mm</b>	GH 6mm <b>Ø 4,5</b>	Titanium	

## CERICX 3.3 healing caps (gingiva former)





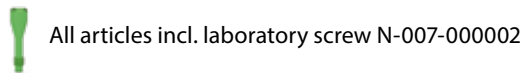
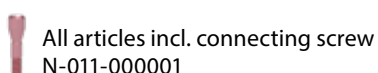

Article no.	Article	Dimensions	Material	
N-004-116003	ICX-3.3 CERICX Healing cap	Ø=7 GH=3mm	Titanium	
N-004-116004	ICX-3.3 CERICX Healing cap	Ø=7 GH=4mm	Titanium	
N-004-116005	ICX-3.3 CERICX Healing cap	Ø=7 GH=5mm	Titanium	

## ICX-3.3 Healing caps, individualizable

Article no.	Article	Dimensions	Material	
N-004-504015	ICX-3.3 Healing cap individual	Ø=4.0 GH=1.5mm	PEEK	
N-004-504035	ICX-3.3 Healing cap individual	Ø=4.0 GH=3.5mm	PEEK	



### Impression posts & model analogs

Artikel-Nr.	Artikel	Dimensionen	Material	
N-005-020002	ICX Ø 3.3 Impression post <b>closed</b>	H 10.4mm Ø 4.5	Titanium	
N-005-040010	ICX-Abdruckkappe, rosa, <b>10er-Pack</b>		Kunststoff	
N-005-030001	ICX Ø 3.3 Impression post <b>open</b>	H 8.5mm Ø 4.5	Titanium	
N-005-030002	ICX Ø 3.3 Impression post <b>open, long</b>	H 15mm Ø 4.5	Titanium	
N-006-010003	ICX Ø 3.3 Model analog standard BL CAD/CAM	Ø 4.0 L 10mm	Titanium	
N-006-010008	ICX Ø 3.3 Model analog TL CAD/CAM	Ø 4.0 L 10mm	Titanium	

**Note:** The screwing-in torque of 5 to 10Ncm should not be exceeded. Please screw in all ICX cover screws and healing caps only by hand. If you screw them in with 20 or more Ncm, there is a risk that conical forces will be created, which will make it almost impossible to loosen them later.

**Note:** H = Length from implant top edge - GH = Gingival height

Dear customers,

**Please note the two different platforms of the BL and TL implants. Select the BL and TL laboratory analogs accordingly.** This is important if the prosthetics later have to touch the different platforms of the implants due to the low emergence profile. different platforms of the implants (GH 0mm).

Your medentis team

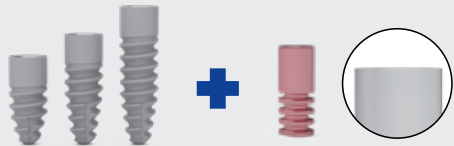

**ICX-Ø 3.3mm BL (Bone Level)**  
Ø 3.3mm

**Art.-No.: N-006-010003**



**ICX-Ø 3.3mm TL (Tissue Level)**  
Ø 3.3mm



**Art.-No.: N-006-010008**





# OVERVIEW

## ICX titanium abutments for cemented restoration ICX-Ø3.3mm





### ICX-Titanium-abutments

Article-No.	Article	Dimensions	Material	
N-007-020401	ICX Ø 3.3 abutment <b>straight, 1mm</b>	GH 1mm Ø 4.0 K 5.5mm	Titanium	
N-007-020402	ICX Ø 3.3 abutment <b>straight, 2mm</b>	GH 2mm Ø 4.0 K 5.5mm	Titanium	
N-007-020403	ICX Ø 3.3 abutment <b>straight, 3mm</b>	GH 3mm Ø 4.0 K 5.5mm	Titanium	

### ICX-Titanium-Aesthetic abutments

Article-No.		Article	Dimensions	Material	
N-010-010005	 <b>Only for ICX bone level Implants</b>	ICX Aesthetic Line titanium abutment, <b>0° straight, Ø 3.7mm</b>	<b>GH 1:</b> 0.5mm <b>GH 2:</b> 1.5mm K 8mm	Titanium	 <b>BL</b>
N-010-020005		ICX Aesthetics Line titanium abutment, <b>15°, Ø 3.7mm</b>	<b>GH 1:</b> 0.5mm <b>GH 2:</b> 1.5mm K 8mm	Titanium	
N-010-040005		ICX Aesthetics Line titanium abutment, <b>25°, Ø 3.7mm</b>	<b>GH 1:</b> 0.5mm <b>GH 2:</b> 1.5mm K 8mm	Titanium	

### ICX-Titanium-Aesthetic abutments

Article-No.	Article	Dimensions	Material	
N-010-020010	ICX Ø 3.3 Aesthetic <b>15°, 1mm</b>	<b>GH 1:</b> 1mm <b>GH 2:</b> 3mm Ø 4.0 K 7.4mm	Titanium	
N-010-020020	ICX Ø 3.3 Aesthetic <b>15°, 2mm</b>	<b>GH 1:</b> 2mm <b>GH 2:</b> 4mm Ø 4.0 K 7.4mm	Titanium	
N-010-040010	ICX Ø 3.3 Aesthetic <b>25°, 1mm</b>	<b>GH 1:</b> 1mm <b>GH 2:</b> 3mm Ø 4.0 K 7.4mm	Titanium	
N-010-040020	ICX Ø 3.3 Aesthetic <b>25°, 2mm</b>	<b>GH 1:</b> 2mm <b>GH 2:</b> 4mm Ø 4.0 K 7.4mm	Titanium	

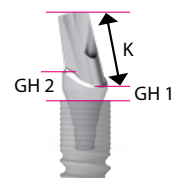

 All articles incl. connection screw  
N-011-000001

 All articles incl. laboratory screw N-007-000002



# OVERVIEW - PROSTHETICS ICX-Ø3,3mm: Adhesive bases and gating

## Adhesive and scan abutments

Article-No.	Article	Dimensions	Material	
N-029-000001	ICX-3.3 Adhesive base	Ø=3.6mm <b>GH=0.5mm</b> K=3.5mm	Titanium	
N-029-000008	ICX-3.3 Adhesive base	Ø=3.6mm <b>GH=1.5mm</b> K=3.5mm	Titanium	
N-029-000007	ICX-3.3 Adhesive base	Ø=3.6mm <b>GH=2.5mm</b> K=3.5mm	Titanium	
N-030-000003	ICX Ø 3,3 Scanabutment <b>narrow coated</b>	H 11.5mm Ø 4.1	Titanium	

 All articles incl. connection screw  
N-011-000001

 All articles incl. laboratory screw N-007-000002



## CoCr-Abutment

Article-No.		Article	Dimensions	Material
N-008-020001		<b>ICX-CoCr abutment</b> (cast-on able with NEM), with hex	Ø 3.6mm GH: 0.5mm K: 5mm Plastic sleeve: 9mm	CoCr Biodur CCM/BC NEM castable (Note CTE values when firing on ceramics)

 All articles incl. connection screw  
N-011-000001

 All articles incl. laboratory screw N-007-000002

## ICX-Cerec® adhesive bases (only compatible with Sirona® system)

Article-No.		Article	Dimensions	Material
N-029-000050		ICX-Cerec® adhesive base with hex for Cerec® L block, incl. scan cap white (Bluecam),	GH 1mm K 4.65mm Ø 4.5mm	Titanium
<b>N-030-000052</b>		ICX-Cerec®- <b>Scanpost L</b> for C-029-000050 with hex incl. scan cap white (Bluecam)	GH 2.5mm K 4.65mm Ø 4.5mm	Titanium

**NOTE:** IN GENERAL, A SCAN VIA THE RESPECTIVE SCANPOST IS ALWAYS RECOMMENDED!  
THE CORRESPONDING DATA SET MUST BE SELECTED FOR SCANPOST.





THE CORRESPONDING CAD/CAM DATA RECORD IS STORED AS THE ALPHATECH 3.4,  
OR FRIADENT FX 3.4 IN THE SIRONA® SYSTEM (S BLOCK).

# OVERVIEW - PROSTHETICS ICX-Ø3,3mm: CERICX-Ø 3,3mm-Abutments

Tooth colour „bright“ **A**  
corresponds to:  
approx. A1, A2, B1

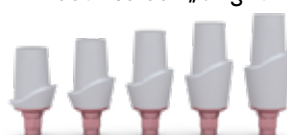
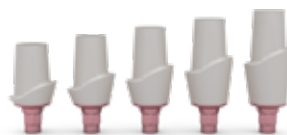
Tooth colour „standard“ **B**  
corresponds to:  
approx. A3, B2

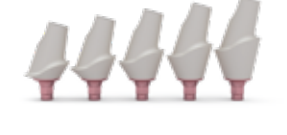
Tooth colour „dark“ **C**  
corresponds to:  
approx. A3.5 B3









Article-No.	Article	Dimensions	Material	
N-036-A/B/C 10501	ICX Ø 3.3 CerICX Abutment <b>straight 1mm</b>	Ø 5.5mm/ Ø 6.5mm GH 1.2/3.1mm K 6.5mm	Titanium	<p>A = Tooth colour „bright“</p>  <p>B = Tooth colour „standard“</p>  <p>C = Tooth colour „dark“</p> 
N-036-A/B/C 10502	ICX Ø 3.3 CerICX Abutment <b>straight 2mm</b>	Ø 5.5mm/ Ø 6.5mm GH 2.2/4.1mm K 6.5mm	Titanium	
N-036-A/B/C 10503	ICX Ø 3.3 CerICX Abutment <b>straight 3mm</b>	Ø 5.5mm/ Ø 6.5mm GH 3.2/5.1mm K 6,5mm	Titanium	
N-036-A/B/C 10504	ICX Ø 3.3 CerICX Abutment <b>straight 4mm</b>	Ø 5.5mm/ Ø 6.5mm GH 4.2/6.1mm K 6.5mm	Titanium	
N-036-A/B/C 10505	ICX Ø 3.3 CerICX Abutment <b>straight 5mm</b>	Ø 5.5mm/ Ø 6.5mm GH 5.2/7.1mm K 6.5mm	Titanium	
N-036-A/B/ C20005	ICX Ø 3,3 CERICX <b>15° Aesthetics 0.5mm</b>	Ø 5.5mm/ Ø 6.5mm GH 1.2/3.2mm K 7mm	Titanium	<p>A = Tooth colour „bright“</p>  <p>B = Tooth colour „standard“</p>  <p>C = Tooth colour „dark“</p> 
N-036-A/B/C 20015	ICX Ø 3.3 CerICX Abutment <b>15° Aesthetics 1.5mm</b>	Ø 5,5mm/ Ø 6,5mm GH 2,2/4,2mm K 7mm	Titanium	
N-036-A/B/C 20025	ICX Ø 3.3 CerICX Abutment <b>15° Aesthetics 2.5mm</b>	Ø 5.5mm/ Ø 6.5mm GH 3.2/5.2mm K 7mm	Titanium	
N-036-A/B/C 20035	ICX Ø 3.3 CerICX Abutment <b>15° Aesthetics 3.5mm</b>	Ø 5.5mm/ Ø 6.5mm GH 4.2/6.2mm K 7mm	Titanium	
N-036-A/B/C 20045	ICX Ø 3.3 CerICX Abutment <b>15° Aesthetics 4.5mm</b>	Ø 5.5mm/ Ø 6.5mm GH 5.2/7.2mm K 7mm	Titanium	

 All articles incl. connection screw  
N-011-000001

 All articles incl. laboratory screw N-007-000002

# OVERVIEW - PROSTHETICS ICX-Ø3,3mm: ICX-MULTI® CONCEPT = 4-ON-ICX AND 6-ON-ICX

## ICX-MULTI®-abutments



Article-No.	Article	Dimensions	Material	
N-020-750010	ICX Ø 3,3 MULTI Abutment <b>straight 1mm</b>	K 2.2mm GH 1mm Ø 4.8	Titanium	
N-020-750020	ICX Ø 3,3 MULTI Abutment <b>straight 2mm</b>	K 2.2mm GH 2mm Ø 4.8	Titanium	
N-020-750030	ICX Ø 3,3 MULTI Abutment <b>straight 3mm</b>	K 2.2mm GH 3mm Ø 4.8	Titanium	
N-020-751710	ICX Ø 3,3 MULTI Abutment <b>17° 1mm hex</b>	K 2.2mm GH 1 = 1mm GH 2 = 2.4mm Ø 4.8	Titanium	
N-020-751720	ICX Ø 3,3 MULTI Abutment <b>17° 2mm hex</b>	K 2.2mm GH 1 = 2mm GH 2 = 3.6mm Ø 4.8	Titanium	
N-020-751730	ICX Ø 3,3 MULTI Abutment <b>17° 3mm hex</b>	K 2.2mm GH 1 = 3mm GH 2 = 4.6mm Ø 4.8	Titanium	
N-020-753510	ICX Ø 3,3 MULTI Abutment <b>35° 1mm hex</b>	K 2.2mm GH 1 = 1mm GH 2 = 3.75mm Ø 4.8	Titanium	
N-020-753520	ICX Ø 3,3 MULTI Abutment <b>35° 2mm hex</b>	K 2.2mm GH 1 = 2mm GH 2 = 4.75mm Ø 4.8	Titanium	
N-020-753530	ICX Ø 3,3 MULTI Abutment <b>35° 3mm hex</b>	K 2.2mm GH 1 = 3mm GH 2 = 5.75mm Ø 4.8	Titanium	

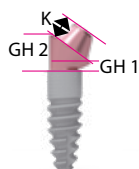

All articles incl. connecting screw  
N-020-000010



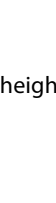











Note: GH = Gingiva height · K = Chimney height

Article-No.	Article	Dimensions	Material	
C-015-100030	ICX-MULTI Hex tool SW 1.2mm medium	SW 1.2mm	Stainless steel	
C-020-000001	ICX-MULTI insertion tool SW 3,2mm for straight multi abutments <b>Mandatory!</b>	SW 3.2mm	Stainless steel	

# OVERVIEW - PROSTHETICS ICX-Ø3,3mm: ICX-MULTI® CONCEPT = 4-ON-ICX AND 6-ON-ICX

Required minimum construction height is 5.5mm



Article-No.		Article	Dimensions	Material
C-003-000005		ICX-MULTI Protection cap	Ø 4.8 L 4.6mm	Titanium
C-005-070001		ICX-MULTI impression posts, closed, incl. impression cap	L 11mm	Titanium
C-005-070002		ICX-MULTI impression posts, open, short incl. impression aid	L 13mm	Titanium
C-005-070020		ICX-MULTI impression posts, open, long incl. impression aid	L 16.7mm	Titanium
C-006-010007		ICX-MULTI Model analog CAD/CAM	L 11mm K 2,mm	Titanium
C-020-951120		ICX-MULTI Prosthetic abutment, Titanium	Ø 4.8 L 12mm (shortenable to 4.1mm)	Titanium
C-020-952120		ICX-MULTI Prosthetic abutment, Plastic	Ø 4.8 L 12mm (shortenable to 4.1mm)	Plastic burnable
C-020-953120		ICX-MULTI Prosthetic abutment PEEK (PROVISIONAL/BITE REGISTRATION)	Ø 4.8 L 12mm (shortenable to 4.1mm)	Peek
C-029-002010		ICX-MULTI adhesive base (for bars and resin veneer bridges)	Ø 4.8 L 5.5mm	Titanium
C-029-002011		ICX-MULTI adhesive base GH 0mm, (for ceramic veneer bridges)	Ø 5.4mm, L 5.5mm	Titanium
C-030-000010		ICX-MULTI Scan cap	L 12.5mm B 4.5mm T 6.5mm	Peek
C-030-000013		ICX Multi Scan base narrow	Ø 4.10mm L 10mm	Titanium
C-031-100001		ICX-Maximus cap, GH 3mm, (additionally to GH ICX-multi abutment)	Ø 4.8 L 4.4mm	Titanium



incl. prosthetic screw C-020-000011 (connection screw to ICX-MULTI abutment)

# OVERVIEW - PROSTHETICS ICX-Ø3,3mm: ICX-MULTI® CONCEPT = 4-ON-ICX AND 6-ON-ICX

required minimum construction height is 5.5mm

Article-No.		Article	Dimensions	Material
C-020-956120		ICX-MULTI prosthetic abutment CoCr Biodur CCM/BC NEM cast-on	Ø 4.8mm L 7mm	CoCr Biodur CCM/ BC
C-020-955120		ICX-MULTI WeldOn abutment for welding of several superstructures with the aid of a titanium wire	Ø 4.8mm L 12mm	Titanium
C-020-955121		ICX-MULTI WeldOn abutment for welding of several superstructures with the aid of a titanium wire	Ø 5.1mm L 10.5mm	Titanium

 incl. prosthetic screw C-020-000011  
(connection screw to ICX-MULTI abutment)

## Field of application and indication



The ICX-MULTI® concept is a prosthetic concept for immediate restoration of edentulous patients. For better support of the provisional restoration, it is possible for the posterior implants to be placed at a 17° or 35° angle distally. This angulation is compensated by the special abutments.



## 4-ON-ICX



# OVERVIEW - PROSTHETICS ICX-Ø3,3mm: Adhesive and scan abutments - t-bona - ICX-Maximus

## t-bona ball head abutments

Article-No.	Article	Dimensions	Material	
N-022-060001	ICX Ø 3.3 t-bona, <b>standard, 1mm</b>	GH 1mm	Titanium	
N-022-060002	ICX Ø 3.3 t-bona, <b>standard, 2mm</b>	GH 2mm	Titanium	
N-022-060003	ICX Ø 3.3 t-bona, <b>standard, 3mm</b>	GH 3mm	Titanium	

Article-No.		Article	Dimensions	Material
C-015-100007		ICX-t-bona ball head insertion tool	L 19mm	Edelstahl









## ICX-Maximus-abutments

Article-No.	Article	Dimensions	Material	
N-031-010001	ICX Ø 3.3 Maximus, <b>two-piece 1mm</b>	GH 1mm	Titanium	
N-031-010002	ICX Ø 3.3 Maximus, <b>two-piece 2mm</b>	GH 2mm	Titanium	
N-031-010003	ICX Ø 3.3 Maximus, <b>two-piece 3mm</b>	GH 3mm	Titanium	



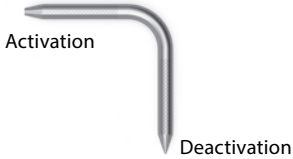

 All articles incl. connection screw  
N-011-000001

# OVERVIEW - PROSTHETICS ICX-Ø3,3mm: ICX-t-bona ball head system

## t-ecco/matrices

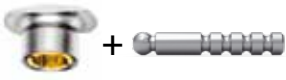
Article-No.		Article	Material
T-13825		t-ecco, matrice, complete, incl. golden inner matrix, red plastic auxiliary ring and model analog	Titanium plus AuPt
T-13836		t-ecco, matrice, single <b>without golden inner matrix</b>	Titanium
T-13833		t-ecco, golden inner matrix	AuPt
T-13846		t-ecco, golden inner matrix (weak)	Titanium grade5
T-13845		t-ecco, red inner matrix (strong)	Titanium grade5
EK-833100		Model analog	Brass
T-10571		t-ecco activator/deactivator	Stainless steel
960002		Hex tool, SW 0.9 short, L 20mm	Stainless steel
C-015-100029		Hex tool, SW 0.9 long, one-piece L 35mm	Stainless steel

## Dalbo®-PLUS/matrice

Article-No.		Article	Material
DP-055890		Dalbo PLUS Female TE set elliptical Complete incl. Dalbo PLUS lamella insert	Titanium plus Elitor
DP-055643		Dalbo PLUS lamella insert (no indentation)	Elitor
DP-050068		Dalbo PLUS Tuning soft lamella insert (1 indentation) for ball head abrasion up to 0.05mm	Elitor
DP-055687		Dalbo PLUS Tuning slat insert (2 indentation) for ball head abrasion from 0.05mm	Elitor
DP-072609		Dalbo PLUS tool/activator (per ¼ turn increases the trigger force by 200g)	Stainless steel















**Note: Please be sure to use the Dalbo-PLUS tool (DP-072609) in order to adjust the retention individually according to the situation.**



# OVERVIEW - PROSTHETICS ICX-Ø3,3mm: ICX Maximus Accessories

## Matrices

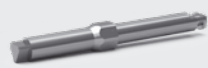
### ICX Maximus Accessories:

Article-No.		Article	Material
C-031-852400		Retention insert transparent Pull-off force approx. 2.3 kg, strong Divergence compensation $\pm 10^\circ$	Plastic (pack of 4)
C-031-852700		Retention insert pink Trigger force approx. 1.6 kg, medium Divergence compensation $\pm 10^\circ$	Plastic (pack of 4)
C-031-852900		Retention insert blue Pull-off force approx. 0.7 kg, weak Divergence compensation $\pm 10^\circ$	Plastic (pack of 4)
C-031-854700		Retention insert green Pull-off force approx. 1.8 kg, medium Divergence compensation $\pm 20$	Plastic (pack of 4)
C-031-854800		Retention insert red Pull-off force approx. 0.4 kg, weak Divergence compensation $\pm 20$	Plastic (pack of 4)
C-031-851500		Processing male black, no retention (laboratory)	Plastic (pack of 4)
C-031-852300		ICX-Maximus Block out Spacer, Pack of 2	Plastic (pack of 2)
C-031-851902		Processing package (titanium cap with black laboratory insert, spacer ring and retention inserts)	Titanium/ Plastic (2er Pack)
C-031-851910		Processing package (titanium cap with black laboratory insert, spacer ring and retention inserts)	Titanium/ Plastic (pack of 10)
C-031-009142		Matrice	Titanium
C-015-100032		Core Tool (general purpose tool)	Stainless steel
C-031-850501		Impression post	Titanium (pack of 4)
C-031-853000		Model analog Ø4mm	Titanium (pack of 4)
C-015-100018		Triangular turning tool 25mm (short)	Stainless steel
C-015-100031		Triangular turning tool 30mm (lang)	Stainless steel

The one, & two-piece ICX Maximus abutments are a proprietary development of medentis medical, compatible with the Locator™ abutments. Available for all ICX implants!

Products marked with ® and ™ are registered trademarks of the respective manufacturer.

## OVERVIEW:

# ICX-PREMIUM BL-implants/Pack of 6

## ICX-PREMIUM Implants BONE LEVEL/Pack of 6

All ICX implants are only available in a pack of 6

### Please note

when ordering prosthetic abutments with **GH 0mm**:

**ICX-Tissue Level (TL) implants have - due to the tulip - a different platform as the ICX Bone Level (BL) implants.**

**These prosthetic abutments are explicitly marked in the following.**

### ICX-PREMIUM (BL) Implants red, Ø 3.75mm

Article-No.	
C-001-390080	ICX Ø 3.75 x 8mm (pack of 6)
C-001-390100	ICX Ø 3.75 x 10mm (pack of 6)
C-001-390125	ICX Ø 3.75 x 12.5mm (pack of 6)
C-001-390150	ICX Ø 3.75 x 15mm (pack of 6)

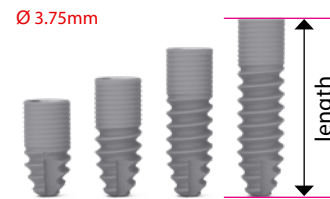

### ICX-PREMIUM (BL) implants green, Ø 4.1mm

Article-No.	
C-001-425080	ICX Ø 4.1 x 8mm (pack of 6)
C-001-425100	ICX Ø 4.1 x 10mm (pack of 6)
C-001-425125	ICX Ø 4.1 x 12.5mm (pack of 6)
C-001-425150	ICX Ø 4.1 x 15mm (pack of 6)

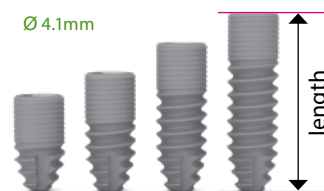

### ICX-PREMIUM (BL) implants blue, Ø 4.8mm

Article-No.	
C-001-480080	ICX Ø 4.8 x 8mm (pack of 6)
C-001-480100	ICX Ø 4.8 x 10mm (pack of 6)
C-001-480125	ICX Ø 4.8 x 12.5mm (pack of 6)
C-001-480150	ICX Ø 4.8 x 15mm (pack of 6)



Single Implantate siehe Seite 28

# OVERVIEW: ICX-PREMIUM TL-implants/Pack of 6

## ICX-PREMIUM TISSUE LEVEL implants/Pack of 6

All ICX-PREMIUM TISSUE LEVEL implants are available in packs of 6 only

### ICX PREMIUM TISSUE LEVEL implants yellow, Ø 3.45mm

Article-No.

C-001-345065	ICX Premium TissueLine Implant Ø 3.45 x 6.5mm (pack of 6)
C-001-345080	ICX Premium TissueLine Implant Ø 3.45 x 8mm (pack of 6)
C-001-345100	ICX Premium TissueLine Implant Ø 3.45 x 10mm (pack of 6)
C-001-345125	ICX Premium TissueLine Implant Ø 3.45 x 12.5mm (pack of 6)

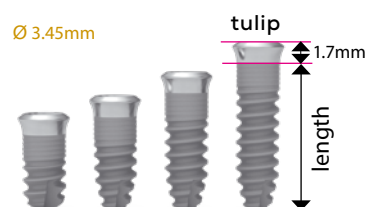

### ICX PREMIUM TISSUE LEVEL implants red, Ø 3.75mm

Article-No.

T-001-375080	ICX Premium TissueLine Implant Ø 3.75 x 8mm (pack of 6) NEW!
T-001-375100	ICX Premium TissueLine Implant Ø 3.75 x 10mm (pack of 6) NEW!
T-001-375125	ICX Premium TissueLine Implant Ø 3.75 x 12.5mm (pack of 6) NEW!



### ICX PREMIUM TISSUE LEVEL implants green, Ø 4.1mm

Article-No.

T-001-425080	ICX Premium TissueLine Implant Ø 4.1 x 8mm (pack of 6) NEW!
T-001-425100	ICX Premium TissueLine Implant Ø 4.1 x 10mm (pack of 6) NEW!
T-001-425125	ICX Premium TissueLine Implant Ø 4.1 x 12.5mm (pack of 6) NEW!

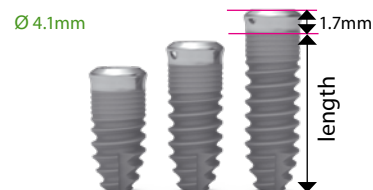

### ICX PREMIUM TISSUE LEVEL implants blue, Ø 4.8mm

Article-No.

T-001-480049	ICX Premium TissueLine Implant Ø 4.8 x 4.9mm (pack of 6) NEW!
T-001-480065	ICX Premium TissueLine Implant Ø 4.8 x 6.5mm (pack of 6) NEW!
T-001-480080	ICX Premium TissueLine Implant Ø 4.8 x 8mm (pack of 6) NEW!
T-001-480100	ICX Premium TissueLine Implant Ø 4.8 x 10mm (pack of 6) NEW!
T-001-480125	ICX Premium TissueLine Implant Ø 4.8 x 12.5mm (pack of 6) NEW!



# OVERVIEW: ICX-PREMIUM Single implants

## ICX-PREMIUM SINGLE-implants

incl. sterile closing cap

### ICX-PREMIUM-TISSUE LEVEL Implants yellow, Ø 3.45mm

Article-No.

S-001-345065	ICX Premium TissueLine Implant Ø 3.45 x 6.5mm
S-001-345080	ICX Premium TissueLine Implant Ø 3.45 x 8mm
S-001-345100	ICX Premium TissueLine Implant Ø 3.45 x 10mm
S-001-345125	ICX Premium TissueLine Implant Ø 3.45 x 12.5mm

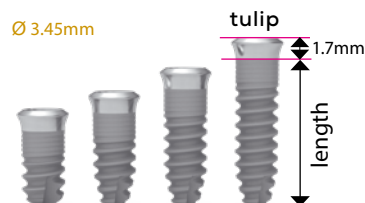

### ICX-PREMIUM (BL) Implants red, Ø 3.75mm

Article-No.

S-001-390080	ICX Ø 3.75 x 8mm
S-001-390100	ICX Ø 3.75 x 10mm
S-001-390125	ICX Ø 3.75 x 12.5mm
S-001-390150	ICX Ø 3.75 x 15mm

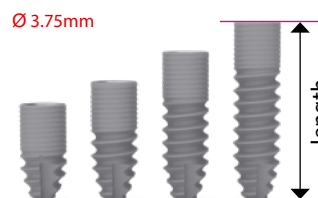

### ICX-PREMIUM (BL) implants green, Ø 4.1mm

Article-No.

S-001-425080	ICX Ø 4.1 x 8mm
S-001-425100	ICX Ø 4.1 x 10mm
S-001-425125	ICX Ø 4.1 x 12.5mm
S-001-425150	ICX Ø 4.1 x 15mm

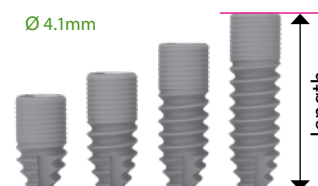

### ICX-PREMIUM (BL) implants blue, Ø 4.8mm

Article-No.

S-001-480080	ICX Ø 4.8 x 8mm
S-001-480100	ICX Ø 4.8 x 10mm
S-001-480125	ICX Ø 4.8 x 12.5mm
S-001-480150	ICX Ø 4.8 x 15mm



#### Note:

medentis medical offers you instruction manuals on the following website: [ifu.medentis.de](http://ifu.medentis.de)

There you can find the manuals for use by entering the article number or retrieve the currently valid instructions for use of the product groups. The prerequisite is an Internet-capable end device at which PDF documents can be opened. If you would like to have the paper version of the instructions for use, please contact us and we will send it to you with UPS Express Saver free of charge by noon on the next working day. Alternatively, the user manual can also be faxed or sent by e-mail.

# OVERVIEW: ICX-ACTIVE MASTER implants/Pack of 6

## ICX-ACTIVE-MASTER BONE LEVEL implants/Pack of 6

All ICX-ACTIVE-MASTER implants are only available in a pack of 6

### ICX-ACTIVE-MASTER Implants red, Ø 3.75mm

Article-No.	
ACM-001-390080	ICX-ACTIVE-MASTER Ø 3.75 · L 8mm (Pack of 6)
ACM-001-390100	ICX-ACTIVE-MASTER Ø 3.75 · L 10mm (Pack of 6)
ACM-001-390125	ICX-ACTIVE-MASTER Ø 3.75 · L 12.5mm (Pack of 6)
ACM-001-390150	ICX-ACTIVE-MASTER Ø 3.75 · L 15mm (Pack of 6)

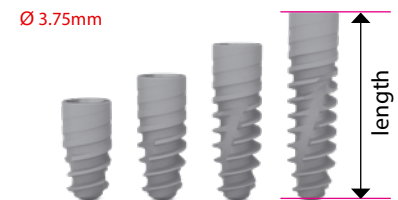

### ICX-ACTIVE-MASTER Implants green, Ø 4.1mm

Article-No.	
ACM-001-425080	ICX-ACTIVE-MASTER Ø 4.1 · L 8mm (Pack of 6)
ACM-001-425100	ICX-ACTIVE-MASTER Ø 4.1 · L 10mm (Pack of 6)
ACM-001-425125	ICX-ACTIVE-MASTER Ø 4.1 · L 12.5mm (Pack of 6)
ACM-001-425150	ICX-ACTIVE-MASTER Ø 4.1 · L 15mm (Pack of 6)

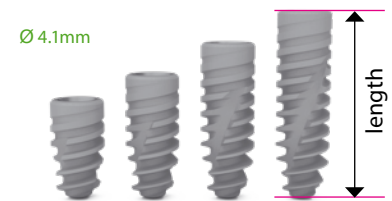

### ICX-ACTIVE-MASTER Implants blue, Ø 4.8mm

Article-No.	
ACM-001-480080	ICX-ACTIVE-MASTER Ø 4.8 · L 8mm (Pack of 6)
ACM-001-480100	ICX-ACTIVE-MASTER Ø 4.8 · L 10mm (Pack of 6)
ACM-001-480125	ICX-ACTIVE-MASTER Ø 4.8 · L 12.5mm (Pack of 6)
ACM-001-480150	ICX-ACTIVE-MASTER Ø 4.8 · L 15mm (Pack of 6)

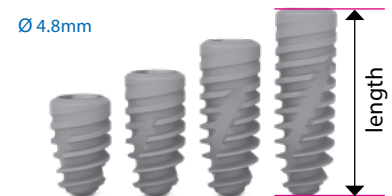

ICX-SHOP!



**BE SMART. BE ICX.**



# OVERVIEW: ICX-ACTIVE MASTER BL Single implants

## ICX-ACTIVE-MASTER BONE LEVEL Single implants

### ICX-ACTIVE-MASTER Implants red, Ø 3.75mm

Article-No.

S-ACM-001-390080	ICX-ACTIVE-MASTER Ø 3.75 · L 8mm (Pack of 6)
S-ACM-001-390100	ICX-ACTIVE-MASTER Ø 3.75 · L 10mm (Pack of 6)
S-ACM-001-390125	ICX-ACTIVE-MASTER Ø 3.75 · L 12.5mm (Pack of 6)
S-ACM-001-390150	ICX-ACTIVE-MASTER Ø 3.75 · L 15mm (Pack of 6)

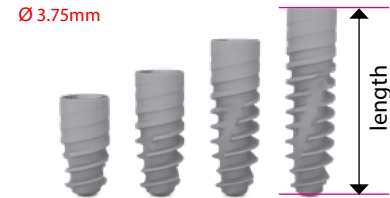

### ICX-ACTIVE-MASTER Implants green, Ø 4.1mm

Article-No.

S-ACM-001-425080	ICX-ACTIVE-MASTER Ø 4.1 · L 8mm (Pack of 6)
S-ACM-001-425100	ICX-ACTIVE-MASTER Ø 4.1 · L 10mm (Pack of 6)
S-ACM-001-425125	ICX-ACTIVE-MASTER Ø 4.1 · L 12.5mm (Pack of 6)
S-ACM-001-425150	ICX-ACTIVE-MASTER Ø 4.1 · L 15mm (Pack of 6)

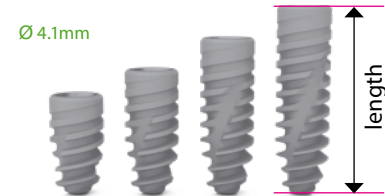

### ICX-ACTIVE-MASTER Implants blue, Ø 4.8mm

Article-No.

S-ACM-001-480080	ICX-ACTIVE-MASTER Ø 4.8 · L 8mm (Pack of 6)
S-ACM-001-480100	ICX-ACTIVE-MASTER Ø 4.8 · L 10mm (Pack of 6)
S-ACM-001-480125	ICX-ACTIVE-MASTER Ø 4.8 · L 12.5mm (Pack of 6)
S-ACM-001-480150	ICX-ACTIVE-MASTER Ø 4.8 · L 15mm (Pack of 6)

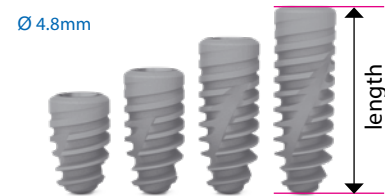

ICX-SHOP!



**BE SMART. BE ICX.**



# OVERVIEW: ICX-ACTIVE MASTER TL implants/Pack of 6

## ICX-ACTIVE-MASTER TISSUE LEVEL implants/Pack of 6

All ICX-ACTIVE MASTER TISSUE LEVEL implants are only available in packs of 6.

### Please note

when ordering prosthetic abutments with **GH 0mm**:

**ICX-Tissue Level (TL) implants have - due to the tulip - a different platform as the ICX Bone Level (BL) implants.**

**These prosthetic abutments are explicitly marked in the following.**

### ICX-ACTIVE MASTER-TISSUE LEVEL implants red, Ø 3.75mm

Article-No.

TAM-001-375080	ICX Active Master TissueLine Implant Ø 3.75 x 8mm (Pack Of 6)
TAM-001-375100	ICX Active Master TissueLine Implant Ø 3.75 x 10mm (Pack Of 6)
TAM-001-375125	ICX Active Master TissueLine Implant Ø 3.75 x 2.5mm (Pack Of 6)

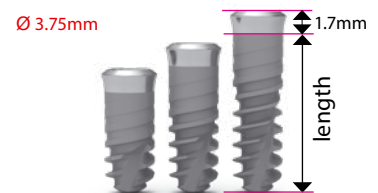

### ICX-ACTIVE MASTER-TISSUE LEVEL implants green, Ø 4.1mm

Article-No.

TAM-001-425080	ICX Active Master TissueLine Implant Ø 4.1 x 8mm (Pack Of 6)
TAM-001-425100	ICX Active Master TissueLine Implant Ø 4.1 x 10mm (Pack Of 6)
TAM-001-425125	ICX Active Master TissueLine Implant Ø 4.1 x 12.5mm (Pack Of 6)

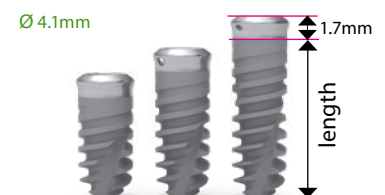

### ICX-ACTIVE MASTER-TISSUE LEVEL implants blue, Ø 4.8mm

Article-No.

TAM-001-480080	ICX Active Master TissueLine Implant Ø 4.8 x 8mm (Pack Of 6)
TAM-001-480100	ICX Active Master TissueLine Implant Ø 4.8 x 10mm (Pack Of 6)
TAM-001-480125	ICX Active Master TissueLine Implant Ø 4.8 x 12.5mm (Pack Of 6)

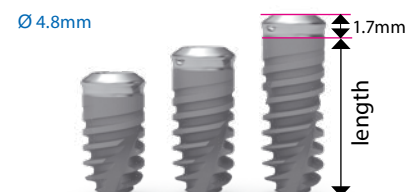

# OVERVIEW: ICX-ACTIVE LIQUID Implants

## ICX-ACTIVE LIQUID/Pack of 6

only in a pack of 6.

Article-No.	Article	Dimensions	Material
LAC-330080	ICX-Active Liquid	Ø 3.3mm, Length 8mm	Titanium
LAC-330100	ICX-Active Liquid	Ø 3.3mm, Length 10mm	Titanium
LAC-330125	ICX-Active Liquid	Ø 3.3mm, Length 12.5mm	Titanium
LAC-390080	ICX-Active Liquid	Ø 3.75mm, Length 8mm	Titanium
LAC-390100	ICX-Active Liquid	Ø 3.75mm, Length 10mm	Titanium
LAC-390125	ICX-Active Liquid	Ø 3.75mm, Length 12.5mm	Titanium
LAC-390150	ICX-Active Liquid	Ø 3.75mm, Length 15mm	Titanium
LAC-425080	ICX-Active Liquid	Ø 4.1mm, Length 8mm	Titanium
LAC-425100	ICX-Active Liquid	Ø 4.1mm Length 10mm	Titanium
LAC-425125	ICX-Active Liquid	Ø 4.1mm, Length 12.5mm	Titanium
LAC-425150	ICX-Active Liquid	Ø 4.1mm, Length 15mm	Titanium
LAC-480080	ICX-Active Liquid	Ø 4.8mm, Length 8mm	Titanium
LAC-480100	ICX-Active Liquid	Ø 4.8mm, Length 10mm	Titanium
LAC-480125	ICX-Active Liquid	Ø 4.8mm, Length 12.5mm	Titanium
LAC-480150	ICX-Active Liquid	Ø 4.8mm, Length 15mm	Titanium



## ICX-ACTIVE LIQUID/Single-Pack

only available in single pack, incl. 1 cover screw!

Article-No.	Article	Dimensions	Material
S-LAC-330080	ICX-Active Liquid	Ø 3.3mm, Length 8mm	Titanium
S-LAC-330100	ICX-Active Liquid	Ø 3.3mm, Length 10mm	Titanium
S-LAC-330125	ICX-Active Liquid	Ø 3.3mm, Length 12.5mm	Titanium
S-LAC-390080	ICX-Active Liquid	Ø 3.75mm, Length 8mm	Titanium
S-LAC-390100	ICX-Active Liquid	Ø 3.75mm, Length 10mm	Titanium
S-LAC-390125	ICX-Active Liquid	Ø 3.75mm, Length 12.5mm	Titanium
S-LAC-390150	ICX-Active Liquid	Ø 3.75mm, Length 15mm	Titanium
S-LAC-425080	ICX-Active Liquid	Ø 4.1mm, Length 8mm	Titanium
S-LAC-425100	ICX-Active Liquid	Ø 4.1mm Length 10mm	Titanium
S-LAC-425125	ICX-Active Liquid	Ø 4.1mm, Length 12.5mm	Titanium
S-LAC-425150	ICX-Active Liquid	Ø 4.1mm, Length 15mm	Titanium
S-LAC-480080	ICX-Active Liquid	Ø 4.8mm, Length 8mm	Titanium
S-LAC-480100	ICX-Active Liquid	Ø 4.8mm, Length 10mm	Titanium
S-LAC-480125	ICX-Active Liquid	Ø 4.8mm, Length 12.5mm	Titanium
S-LAC-480150	ICX-Active Liquid	Ø 4.8mm, Length 15mm	Titanium





# ICX-DIAMOND<sup>®</sup>

THE NEW POWER IMPLANT BY MEDENTIS MEDICAL.

LIQUID

4 implant shapes and 1 prosthetic diameter.  
Available as Bonelevel and Transgingival.

## ICX-DIAMOND<sup>®</sup> LIQUID

TISSUE LEVEL

BONE LEVEL

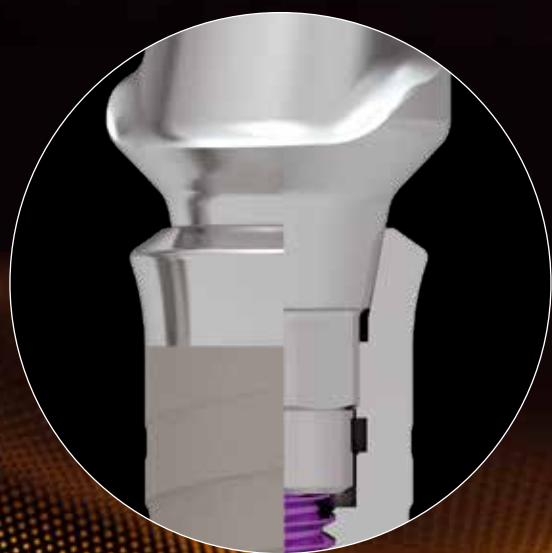

With the unique icx cone system  
from medentis.



# ICX-TISSUE LEVEL

UND

# ICX-BONE LEVEL

SUCCESSFUL USERS TAKE ADVANTAGE OF ALL THE BENEFITS.  
HIGHER EFFICIENCY THROUGH SIMPLICITY.

BE SMART. BE ICX.

medentis  
medical

# OVERVIEW: ICX-DIAMOND BL/TL LIQUID Implants

**NEW ++ NEW!!**

## ICX-DIAMOND PREMIUM BL LIQUID/Pack of 6 freely selectable, made of Giga-Titanium

Article-No.	Article	Dimensions	Material
G-001-330080	ICX-Diamond Premium BL	Ø 3.3x8mm	Giga-Titanium-
G-001-330100	ICX-Diamond Premium BL	Ø 3.3x10mm	Giga-Titanium-
G-001-330125	ICX-Diamond Premium BL	Ø 3.3x12.5mm	Giga-Titanium-
G-001-390080	ICX-Diamond Premium BL	Ø 3.75x8mm	Giga-Titanium-
G-001-390100	ICX-Diamond Premium BL	Ø 3.75x10mm	Giga-Titanium-
G-001-390125	ICX-Diamond Premium BL	Ø 3.75x12.5mm	Giga-Titanium-
G-001-390150	ICX-Diamond Premium BL	Ø 3.75x15mm	Giga-Titanium-
G-001-425080	ICX-Diamond Premium BL	Ø 4.1x8mm	Giga-Titanium-
G-001-425100	ICX-Diamond Premium BL	Ø 4.1x10mm	Giga-Titanium-
G-001-425125	ICX-Diamond Premium BL	Ø 4.1x12.5mm	Giga-Titanium-
G-001-425150	ICX-Diamond Premium BL	Ø 4.1x15mm	Giga-Titanium-
G-001-480080	ICX-Diamond Premium BL	Ø 4.8x8mm	Giga-Titanium-
G-001-480100	ICX-Diamond Premium BL	Ø 4.8x10mm	Giga-Titanium-
G-001-480125	ICX-Diamond Premium BL	Ø 4.8x12.5mm	Giga-Titanium-
G-001-480150	ICX-Diamond Premium BL	Ø 4.8x15mm	Giga-Titanium-

**BONELEVEL**



## ICX-DIAMOND PREMIUM TL LIQUID/Pack of 6 freely selectable, made of Giga-Titanium

Article-No.	Article	Dimensions	Material
GT-001-330080	ICX-Diamond Premium TL	3.3x8mm	Giga-Titanium-
GT-001-330100	ICX-Diamond Premium TL	3.3x10mm	Giga-Titanium-
GT-001-330125	ICX-Diamond Premium TL	3.3x12.5mm	Giga-Titanium-
GT-001-345065	ICX-Diamond Premium TL	3.45x6.5mm	Giga-Titanium-
GT-001-345080	ICX-Diamond Premium TL	3.45x8mm	Giga-Titanium-
GT-001-345100	ICX-Diamond Premium TL	3.45x10mm	Giga-Titanium-
GT-001-345125	ICX-Diamond Premium TL	3.45x12.5mm	Giga-Titanium-
GT-001-390080	ICX-Diamond Premium TL	3.75x8mm	Giga-Titanium-
GT-001-390100	ICX-Diamond Premium TL	3.75x10mm	Giga-Titanium-
GT-001-390125	ICX-Diamond Premium TL	3.75x12.5mm	Giga-Titanium-
GT-001-425080	ICX-Diamond Premium TL	4.1x8mm	Giga-Titanium-
GT-001-425100	ICX-Diamond Premium TL	4.1x10mm	Giga-Titanium-
GT-001-425125	ICX-Diamond Premium TL	4.1x12.5mm	Giga-Titanium-
GT-001-480049	ICX-Diamond Premium TL	4.8x4.9mm	Giga-Titanium-
GT-001-480065	ICX-Diamond Premium TL	4.8x6.5mm	Giga-Titanium-
GT-001-480080	ICX-Diamond Premium TL	4.8x8mm	Giga-Titanium-
GT-001-480100	ICX-Diamond Premium TL	4.8x10mm	Giga-Titanium-
GT-001-480125	ICX-Diamond Premium TL	4.8x12.5mm	Giga-Titanium-

**TISSUE LEVEL**



# OVERVIEW: ICX-DIAMOND BL/TL LIQUID Implants

**NEW ++ NEW!!**

## ICX-DIAMOND ACTIVE MASTER BL LIQUID/Pack of 6 freely selectable, made of Giga-Titanium

Article-No.	Article	Dimensions	Material
GAM-001-330080	ICX-Diamond Active Master BL	Ø 3.3x8mm	Giga-Titanium
GAM-001-330100	ICX-Diamond Active Master BL	Ø 3.3x10mm	Giga-Titanium
GAM-001-330125	ICX-Diamond Active Master BL	Ø 3.3x12.5mm	Giga-Titanium
GAM-001-390080	ICX-Diamond Active Master BL	Ø 3.75x8mm	Giga-Titanium
GAM-001-390100	ICX-Diamond Active Master BL	Ø 3.75x10mm	Giga-Titanium
GAM-001-390125	ICX-Diamond Active Master BL	Ø 3.75x12.5mm	Giga-Titanium
GAM-001-390150	ICX-Diamond Active Master BL	Ø 3.75x15mm	Giga-Titanium
GAM-001-425080	ICX-Diamond Active Master BL	Ø 4.1x8mm	Giga-Titanium
GAM-001-425100	ICX-Diamond Active Master BL	Ø 4.1x10mm	Giga-Titanium
GAM-001-425125	ICX-Diamond Active Master BL	Ø 4.1x12.5mm	Giga-Titanium
GAM-001-425150	ICX-Diamond Active Master BL	Ø 4.1x15mm	Giga-Titanium
GAM-001-480080	ICX-Diamond Active Master BL	Ø 4.8x8mm	Giga-Titanium
GAM-001-480100	ICX-Diamond Active Master BL	Ø 4.8x10mm	Giga-Titanium
GAM-001-480125	ICX-Diamond Active Master BL	Ø 4.8x12.5mm	Giga-Titanium
GAM-001-480150	ICX-Diamond Active Master BL	Ø 4.8x15mm	Giga-Titanium

**BONELEVEL**



**NEW ++ NEW!!**

## ICX-DIAMOND ACTIVE MASTER TL LIQUID/Pack of 6 freely selectable, made of Giga-Titanium

Article-No.	Article	Dimensions	Material
GTAM-001-330080	ICX-Diamond Active Master TL	3.3x8mm	Giga-Titanium
GTAM-001-330100	ICX-Diamond Active Master TL	3.3x10mm	Giga-Titanium
GTAM-001-330125	ICX-Diamond Active Master TL	3.3x12.5mm	Giga-Titanium
GTAM-001-390080	ICX-Diamond Active Master TL	3.75x8mm	Giga-Titanium
GTAM-001-390100	ICX-Diamond Active Master TL	3.75x10mm	Giga-Titanium
GTAM-001-390125	ICX-Diamond Active Master TL	3.75x12.5mm	Giga-Titanium
GTAM-001-425080	ICX-Diamond Active Master TL	4.1x8mm	Giga-Titanium
GTAM-001-425100	ICX-Diamond Active Master TL	4.1x10mm	Giga-Titanium
GTAM-001-425125	ICX-Diamond Active Master TL	4.1x12.5mm	Giga-Titanium
GTAM-001-480080	ICX-Diamond Active Master TL	4.8x8mm	Giga-Titanium
GTAM-001-480100	ICX-Diamond Active Master TL	4.8x10mm	Giga-Titanium
GTAM-001-480125	ICX-Diamond Active Master TL	4.8x12.5mm	Giga-Titanium

**TISSUE LEVEL**



**NEW ++ NEW!!**

\*Only available in packs of 6, freely selectable Definition of Giga-Titanium = Pure Titanium Grade 4KV with 1,100 MPa.

# OVERVIEW: ICX-ACTIVE-WHITE implants

## ICX-ACTIVE-WHITE-Ceramic implants (one-piece)

Article-No.

AW-002-425080	ICX-ACTIVE WHITE-Implant Ø 4.1 · L 8mm, one-piece, GH 2.5mm, K 4.5mm
AW-002-425100	ICX-ACTIVE WHITE-Implant Ø 4.1 · L 10mm, one-piece, GH 2.5mm, K 4.5mm
AW-002-425125	ICX-ACTIVE WHITE-Implant Ø 4.1 · L 12.5mm, one-piece, GH 2.5mm, K 4.5mm
AW-002-425150	ICX-ACTIVE WHITE-Implant Ø 4.1 · L 15mm, one-piece, GH 2.5mm, K 4.5mm
AW-002-426080	ICX-ACTIVE WHITE-Implant Ø 4.1 · L 8mm, one-piece, GH 4.5mm, K 4.5mm
AW-002-426100	ICX-ACTIVE WHITE-Implant Ø 4.1 · L 10mm, one-piece, GH 4.5mm, K 4.5mm
AW-002-426125	ICX-ACTIVE WHITE-Implant Ø 4.1 · L 12.5mm, one-piece, GH 4.5mm, K 4.5mm
AW-002-426150	ICX-ACTIVE WHITE-Implant Ø 4.1 · L 15mm, one-piece, GH 4.5mm, K 4.5mm

**GH 2.5mm**  
Ø 4.1mm



**GH 4.5mm**  
Ø 4.1mm

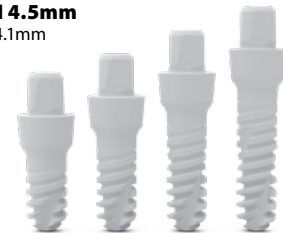

**Note:** GH = Gingiva height

C-021-000002	ICX insertion tool for ICX-ACTIVE WHITE		L 25.6mm	Stainless steel
--------------	---	--	----------	-----------------

The subsequent impression is taken without impression caps and laboratory analogs, using the classic die impression in the practice through to the subsequent saw model in the laboratory.



ICX-SHOPI



**MEINE PRAXIS.  
MEIN SYSTEM.**



# ICX

THE FAIR  
PREMIUM  
IMPLANT-  
SYSTEM.

MANY ICX PRODUCTS NOW ALSO  
AVAILABLE IN STERILE PACKAGING!



ICX-SHOP!























BE SMART. BE ICX.

DIGITAL. DENTAL. FINAL.

















**medentis**<sup>®</sup>  
medical

[www.medentis.de](http://www.medentis.de)

# OVERVIEW: ICX-PREMIUM drills

Article-No.	ICX-PREMIUM drills	Article
C-014-000003		ICX crestotome drill for bone preparation
FIL-186RF		ICX Pilot Drill (Cortical)
C-014-006290		ICX parallel drill <b>standard Ø 2.9 white II</b> ○
C-014-007290		ICX parallel drill <b>hard Ø 2.9 white III</b> ○
C-014-003345		<b>ICX-plus</b> -parallel drill <b>soft Ø 3.45 yellow I</b> ●
C-014-006345		<b>ICX-plus</b> -parallel drill <b>standard Ø 3.45 yellow II</b> ●
C-014-007345		<b>ICX-plus</b> -parallel drill <b>hard Ø 3.45 yellow III</b> ●
C-014-003375		ICX parallel drill <b>soft Ø 3.75 red I</b> ●
C-014-006375		ICX parallel drill <b>standard Ø 3.75 red II</b> ●
C-014-007375		ICX parallel drill <b>hard Ø 3.75 red III</b> ●
C-014-003410		ICX parallel drill <b>soft Ø 4.1 green I</b> ●
C-014-006410		ICX parallel drill <b>standard Ø 4.1 green II</b> ●
C-014-007410		ICX parallel drill <b>hard Ø 4.1 green III</b> ●
C-014-003480		ICX parallel drill <b>soft Ø 4.8 blue I</b> ●
C-014-006480		ICX parallel drill <b>standard Ø 4.8 blue II</b> ●
C-014-007480		ICX parallel drill <b>hard Ø 4.8 blue III</b> ●
C-014-005345		ICX-Stop-drill <b>Ø 3.45 yellow</b> ●
C-014-005375		ICX-Stop-drill <b>Ø 3.75 red</b> ●
C-014-005410		ICX-Stop-drill <b>Ø 4.1 green</b> ●
C-014-005480		ICX-Stop-drill <b>Ø 4.8 blue</b> ●

















# OVERVIEW: ICX-ACTIVE-MASTER drills

Article-No.	ICX-ACTIVE-MASTER drills	Article
ACM-014-003290		ICX-ACTIVE-MASTER Pilot drill
ACM-014-003375		ICX-ACTIVE-MASTER Parallel drill <b>soft Ø 3.75 red I</b> ●
ACM-014-006375		ICX-ACTIVE-MASTER Parallel drill <b>standard Ø 3.75 red II</b> ●
ACM-014-007375		ICX-ACTIVE-MASTER Parallel drill <b>hard Ø 3.75 red III</b> ●
ACM-014-003410		ICX-ACTIVE-MASTER Parallel drill <b>soft Ø 4.1 green II</b> ●
ACM-014-006410		ICX-ACTIVE-MASTER Parallel drill <b>standard Ø 4.1 green II</b> ●
ACM-014-007410		ICX-ACTIVE-MASTER Parallel drill <b>hard Ø 4.1 green III</b> ●
ACM-014-003480		ICX-ACTIVE-MASTER Parallel drill <b>soft Ø 4.8 blue I</b> ●
ACM-014-006480		ICX-ACTIVE-MASTER Parallel drill <b>standard Ø 4.8 blue II</b> ●
ACM-014-007480		ICX-ACTIVE-MASTER Parallel drill <b>hard Ø 4.8 blue III</b> ●
ACM-014-004375		ICX-ACTIVE-MASTER Thread cutter <b>for Ø 3.75 red</b> ●
ACM-014-004410		ICX-ACTIVE-MASTER Thread cutter <b>for Ø 4.1 green</b> ●
ACM-014-004480		ICX-ACTIVE-MASTER Thread cutter <b>for Ø 4.8 blue</b> ●
ACM-014-005375		ICX-ACTIVE-MASTER Stop drill <b>Ø 3.75 red</b> ●
ACM-014-005410		ICX-ACTIVE-MASTER Stop drill <b>Ø 4.1 green</b> ●
ACM-014-005480		ICX-ACTIVE-MASTER Stop drill <b>Ø 4.8 blue</b> ●

**medentis**<sup>®</sup>  
medical

# OVERVIEW: ICX-ALL-IN-ONE drills



















**NEW ++ NEW!!**

Article-No.	Article	
C-018-100001	ICX-All-in-one Box, filled	
AIO-014-007290	ICX-All-in-one Drill Ø 2.9 white ○	
AIO-014-007330	ICX-All-in-one Drill Ø 3.3 pink ●	
AIO-014-007345	ICX-All-in-one Drill Ø 3.45 yellow ●	
AIO-014-007375	ICX-All-in-one Drill Ø 3.75 red ●	
AIO-014-007410	ICX-All-in-one Drill Ø 4.1 green ●	
AIO-014-007480	ICX-All-in-one Drill Ø 4.8 blue ●	
AIO-014-200000	ICX-All-in-one pilot drill	
AIO-014-290080	ICX-All-in-one Drill Ø 2,9 x 8mm, white ○	
AIO-014-290100	ICX-All-in-one Drill Ø 2.9 x 10mm, white ○	
AIO-014-290125	ICX-All-in-one Drill Ø 2.9 x 12.5mm, white ○	
AIO-014-330080	ICX-All-in-one Drill Ø 3.3 x 8mm, pink ●	
AIO-014-330100	ICX-All-in-one Drill Ø 3.3 x 10mm, pink ●	
AIO-014-330125	ICX-All-in-one Drill Ø 3.3 x 12.5mm, pink ●	
AIO-014-345065	ICX-All-in-one Drill Ø 3.45 x 6.5mm, yellow ●	
AIO-014-345080	ICX-All-in-one Drill Ø 3.45 x 8mm, yellow ●	
AIO-014-345100	ICX-All-in-one Drill Ø 3.45 x 10mm, yellow ●	







# OVERVIEW: ICX-ALL-IN-ONE drills

**NEW ++ NEW!!**

AIO-014-345125	ICX-All-in-one Drill Ø 3.45 x 12.5mm, yellow ●	
AIO-014-375080	ICX-All-in-one Drill Ø 3.75 x 8mm, red ●	
AIO-014-375100	ICX-All-in-one Drill Ø 3.75 x 10mm, red ●	
AIO-014-375125	ICX-All-in-one Drill Ø 3.75 x 12.5mm, red ●	
AIO-014-375150	ICX-All-in-one Drill Ø 3.75 x 15mm, red ●	
AIO-014-410080	ICX-All-in-one Drill Ø 4.1 x 8mm, green ●	
AIO-014-410100	ICX-All-in-one Drill Ø 4.1 x 10mm, green ●	
AIO-014-410125	ICX-All-in-one Drill Ø 4.1 x 12.5mm, green ●	
AIO-014-410150	ICX-All-in-one Drill Ø 4.1 x 15mm, green ●	
AIO-014-480049	ICX-All-in-one Drill Ø 4.8 x 4.9mm, blue ●	
AIO-014-480065	ICX-All-in-one Drill Ø 4.8 x 6.5mm, blue ●	
AIO-014-480080	ICX-All-in-one Drill Ø 4.8 x 8mm, blue ●	
AIO-014-480100	ICX-All-in-one Drill Ø 4.8 x 10mm, blue ●	
AIO-014-480125	ICX-All-in-one Drill Ø 4.8 x 12.5mm, blue ●	
AIO-014-480150	ICX-All-in-one Drill Ø 4.8 x 15mm, blue ●	
AIO-014-004330	ICX-All-in-one Thread drill Ø 3.3 pink ●	
AIO-014-004375	ICX-All-in-one Thread drill Ø 3.75 red ●	
AIO-014-004410	ICX-All-in-one Thread drill Ø 4.1 green ●	
AIO-014-004480	ICX-All-in-one Thread drill Ø 4.8 blue ●	

# OVERVIEW: ICX drill stop sleeves

Article-No.	Article	Material		
C-027-129049	ICX drill stop sleeve Ø 2.9mm, Drill depth 4.9mm ○ WHITE	Titanium		<p><b>Ø 2.9mm</b></p> 
C-027-129065	ICX drill stop sleeve Ø 2.9mm, Drill depth 6.5mm ○ WHITE	Titanium		
C-027-129080	ICX drill stop sleeve Ø 2.9mm, Drill depth 8mm ○ WHITE	Titanium		
C-027-129100	ICX drill stop sleeve Ø 2.9mm, Drill depth 10mm ○ WHITE	Titanium		
C-027-129125	ICX drill stop sleeve Ø 2.9mm, Drill depth 12.5mm ○ WHITE	Titanium		
C-027-135049	ICX drill stop sleeve Ø 3.45mm, Drill depth 4.9mm ● YELLOW	Titanium		<p><b>Ø 3.3mm</b> <b>Ø 3.45mm</b></p>  <p>Suitable also for ICX-Ø 3.3mm NARROW</p>
C-027-135065	ICX drill stop sleeve Ø 3.45mm, Drill depth 6.5mm ● YELLOW	Titanium		
C-027-135080	ICX drill stop sleeve Ø 3.45mm, Drill depth 8mm ● YELLOW	Titanium		
C-027-135100	ICX drill stop sleeve Ø 3.45mm, Drill depth 10mm ● YELLOW	Titanium		
C-027-135125	ICX drill stop sleeve Ø 3.45mm, Drill depth 12.5mm ● YELLOW	Titanium		
C-027-138049	ICX drill stop sleeve Ø 3.75mm, Drill depth 4.9mm ● RED	Titanium		<p><b>Ø 3.75mm</b></p> 
C-027-138065	ICX drill stop sleeve Ø 3.75mm, Drill depth 6.5mm ● RED	Titanium		
C-027-138080	ICX drill stop sleeve Ø 3.75mm, Drill depth 8mm ● RED	Titanium		
C-027-138100	ICX drill stop sleeve Ø 3.75mm, Drill depth 10mm ● RED	Titanium		
C-027-138125	ICX drill stop sleeve Ø 3.75mm, Drill depth 12.5mm ● RED	Titanium		
C-027-141049	ICX drill stop sleeve Ø 4.1mm, Drill depth 4.9mm ● GREEN	Titanium		<p><b>Ø 4.1mm</b></p> 
C-027-141065	ICX drill stop sleeve Ø 4.1mm, Drill depth 6.5mm ● GREEN	Titanium		
C-027-141080	ICX drill stop sleeve Ø 4.1mm, Drill depth 8mm ● GREEN	Titanium		
C-027-141100	ICX drill stop sleeve Ø 4.1mm, Drill depth 10mm ● GREEN	Titanium		
C-027-141125	ICX drill stop sleeve Ø 4.1mm, Drill depth 12.5mm ● GREEN	Titanium		

## OVERVIEW:

# ICX drill stop sleeves / ICX Bonespreader

Article-No.	Article	Material	
C-027-148049	ICX drill stop sleeve Ø 4.8mm, Drill depth 4.9mm ● BLUE	Titanium	<p><b>Ø 4.8mm</b></p>  <p>Bohrstoppöhlsen auch passend zu AIO-Bohrer, blau, für D1 Knochen!</p>
C-027-148065	ICX drill stop sleeve Ø 4.8mm, Drill depth 6.5mm ● BLUE	Titanium	
C-027-148080	ICX drill stop sleeve Ø 4.8mm, Drill depth 8mm ● BLUE	Titanium	
C-027-148100	ICX drill stop sleeve Ø 4.8mm, Drill depth 10mm ● BLUE	Titanium	
C-027-148125	ICX drill stop sleeve Ø 4.8mm, Drill depth 12.5mm ● BLUE	Titanium	

Article-No.	Article	Material	
C-018-000016	ICX Drill Stop Sleeve-Box <b>(without content)</b>	Plastic	
C-018-000017	ICX Drill Stop Sleeve-Box <b>(incl. 25 titanium drill stop sleeves)</b>	Plastic, sterilizable	

PROFESSIONAL REMOVAL OF AN ICX DRILL STOP SLEEVE FROM THE BOX:

Step 1 from 3



Step 2 from 3



Step 3 from 3





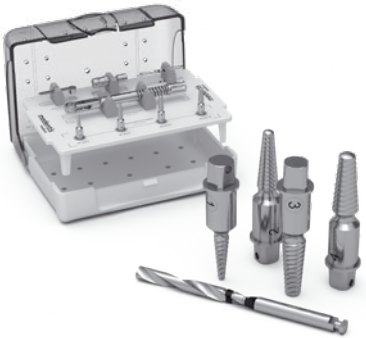

## ICX-Bonespreader-Box

Article-No.	Article	Material	
C-032-100001	ICX BONESPREADER BOX filled	Plastic	
C-014-600001	ICX BoneSpreader No. 1	Titanium	
C-014-600002	ICX BoneSpreader No. 2	Titanium	
C-014-600003	ICX BoneSpreader No. 3	Titanium	
C-014-600004	ICX BoneSpreader No. 4	Titanium	
960001	ICX Ratchet	Stainless steel	
960007	ICX Universal Handpiece		
C-021-000002	ICX Wrench Massive abutment		
C-032-020110	ICX-Magellan universal drill short Ø2,0 for reduction sleeve		

# OVERVIEW:

## ICX cover screws and healing caps (healing abutments)

### Ø 3,45 to Ø 4,8 mm Implants

Article-No.	Article	Dimensions	Material			
C-003-000001	ICX-cover screw	GH 0mm	Titanium			
C-003-000002	ICX-cover screw, sterile <b>(Pack of 6)</b>	GH 0mm	Titanium			
C-003-000021	ICX-cover screw, <b>blue</b> , Ø 3.1mm	GH 2mm	Titanium			
C-003-000022	ICX-cover screw, <b>blue</b> , Ø 3.75mm	GH 0.5mm	Titanium			
C-004-444720	ICX healing cap <b>bottle size</b> Ø 4.7/3.9mm	GH 2mm L 3.5mm	Titanium		<p style="text-align: center;"><b>Ø 4.7/3.9mm</b></p> 	
C-004-444730	ICX healing cap <b>bottle size</b> Ø 4.7/3.9mm	GH 3mm L 4.5mm	Titanium			
C-004-444740	ICX healing cap <b>bottle size</b> Ø 4.7/3.9mm	GH 4mm L 5.5mm	Titanium			
C-004-444750	ICX healing cap <b>bottle size</b> Ø 4.7/3.9mm	GH 5mm L 6.5mm	Titanium			
C-004-004510	ICX healing cap Ø 4.7mm	GH 1mm	Titanium		<p style="text-align: center;"><b>Ø 4.7mm</b></p> 	
C-004-004520	ICX healing cap Ø 4.7mm	GH 2mm	Titanium			
C-004-004530	ICX healing cap Ø 4.7mm	GH 3mm	Titanium			
C-004-004540	ICX healing cap Ø 4.7mm	GH 4mm	Titanium			
C-004-004550	ICX healing cap Ø 4.7mm	GH 5mm	Titanium			
C-004-004560	ICX healing cap Ø 4.7mm	GH 6mm	Titanium			
C-004-006020	ICX healing cap Ø 6mm	GH 2mm	Titanium		<p style="text-align: center;"><b>Ø 6mm</b></p> 	
C-004-006030	ICX healing cap Ø 6mm	GH 3mm	Titanium			
C-004-006040	ICX healing cap Ø 6mm	GH 4mm	Titanium			
C-004-006050	ICX healing cap Ø 6mm	GH 5mm	Titanium			
C-004-006060	ICX healing cap Ø 6mm	GH 6mm	Titanium			
C-004-008030	ICX healing cap Ø 8mm	GH 3mm	Titanium		<p style="text-align: center;"><b>Ø 8mm</b></p> 	
C-004-008050	ICX healing cap Ø 8mm	GH 5mm	Titanium			

**Note:** The tightening torque of 5 to 10Ncm should not be exceeded. Please screw in all ICX cover and healing caps by hand only. If you screw them in with 20 or more Ncm, there is a risk that conical forces will be created, which will make it almost impossible to loosen them later.

Hinweis: L = Length From implant top edge  
GH = Gingiva height

## OVERVIEW:

### ICX healing caps (Gingiva formers) customizable (Temporary abutments)



#### Ø 3,45 to Ø 4,8 mm Implants

Article-No.	Article	Dimensions	Material		
C-004-504720	ICX healing cap, customizable with hex, Ø 4.7mm	GH 2mm K 6mm	PEEK, sterilizable		
C-004-504740	ICX healing cap, customizable with hex, Ø 4.7mm	GH 4mm K 6mm	PEEK, sterilizable		
C-004-514720	ICX healing cap, customizable without hex, Ø 4,7mm	GH 2mm K 6mm	PEEK, sterilizable		
C-004-514740	ICX healing cap, customizable without hex, Ø 4,7mm	GH 4mm K 6mm	PEEK, sterilizable		
C-004-524706	ICX healing cap, customizable with hex, Ø 5mm	L 6.5mm	PEEK, sterilizable		
C-004-524708	ICX healing cap, customizable with hex, Ø 5mm	L 8.5mm	PEEK, sterilizable		
C-004-524710	ICX healing cap, customizable with hex, Ø 5mm	L 10.5mm	PEEK, sterilizable		
C-004-526006	ICX healing cap, customizable with hex, Ø 7mm	L 6.5mm	PEEK, sterilizable		
C-004-526008	ICX healing cap, customizable with hex, Ø 7mm	L 8.5mm	PEEK, sterilizable		
C-004-526010	ICX healing cap, customizable with hex, Ø 7mm	L 10.5mm	PEEK, sterilizable		

Article-No.	Article	Dimensions	Material		
C-004-034550	Healing cap only for TISSUE LEVEL (TL) Implants rotation-locked	Ø 5mm L 5mm	PEEK, sterilizable		



All articles incl. connection screw  
C-011-000001

Article-No.	Article	Dimensions	Material		
C-003-000100	ICX Bone Ring Set consisting of lock screw and cover screw	GH 0mm	Titanium		
C-015-100030	ICX-MULTI hex tool SW 1,2mm medium	SW 1.2mm	Stainless steel		

**Note:** GH = Gingival height

K = Chimney height

L = Length from upper implant edge

## OVERVIEW: ICX-TL healing cap conical

Article-No.		Dimensions	Material		
C-004-245010	ICX-TL-Healing cap conical	Ø 5mm 1mm GH	Titanium		
C-004-245020	ICX-TL-Healing cap conical	Ø 5mm 2mm GH	Titanium		
C-004-245030	ICX-TL-Healing cap conical	Ø 5mm 3mm GH	Titanium		
C-004-245040	ICX-TL-Healing cap conical	Ø 5mm 4mm GH	Titanium		
C-004-245060	ICX-TL-Healing cap conical	Ø 5mm 6mm GH	Titanium		



### Article:

#### ICX-TL-Healing cap conical





- form an extended emergence profile for all subsequent restorations on abutments and adhesive bases, from GH 0mm
- protect the tulip platform during the healing process
- one-piece
- lie on the TL platform and grip around the 0.25mm circularly sloping tulip.
- the cone is at 4 degrees, Ø5,2mm



## OVERVIEW:

# CERICX healing cap & impression coping

For an emergence profile precisely matched to CERICX abutments and correspondingly formed and its subsequent impression. This makes it a complete system.



Article-No.		Dimensions	Material		
C-004-116001	CERICX healing cap matching to CERICX abutments straight 1mm C-036-A/B/C10501	Ø 6mm <b>GH 3mm</b>	Titanium		 <p>For an optimally broadened emergence profile (individual abutments and adhesive bases)</p>
C-004-116002	CERICX healing cap matching to CERICX abutments straight 2mm C-036-A/B/C10502	Ø 6mm <b>GH 4mm</b>	Titanium		
C-004-116003	CERICX healing cap matching to CERICX abutments straight 3mm C-036-A/B/C10503	Ø 6mm <b>GH 5mm</b>	Titanium		
C-004-116004	CERICX healing cap matching to CERICX abutments straight 4mm C-036-A/B/C10504	Ø 6mm <b>GH 6mm</b>	Titanium		
C-005-020005	CERICX impression coping, closed	Ø 7mm L 13mm	Titanium		
C-005-030012	CERICX impression coping, open, short	Ø 5.5mm L 9mm	Titanium		
C-005-030011	CERICX impression coping, open, long	Ø 5.5mm L 16mm	Titanium		

**Note:** GH = Gingiva height · L = Length from upper implant edge



# OVERVIEW: ICX-impression post

Ø 3,45 to Ø 4,8 mm Implants

## ICX impression, closed

Article-No.		Article	Dimensions	Material
C-005-020002		ICX titanium impression post, blue 3-pieces consisting of: Impression coping closed, connection screw, impression cap	L 11.5mm incl. cap	Titanium
C-005-040010		ICX impression cap, blue, pack of 10		Plastic

## ICX impression, open

Article-No.		Article	Dimensions	Material
C-005-030001		ICX titanium impression post, short, 2 pieces, Ø 4.5mm consisting of: Impression coping open, connection screw, impression aid	L 8mm	Titanium
C-005-030002		ICX titanium impression post, long, 2 pieces, Ø 4.5mm consisting of: Impression coping open, connection screw, impression aid	L 15.5mm	Titanium

**Note:** L = Length from implant top edge



# OVERVIEW: ICX model analog

Ø 3,45 to Ø 4,8 mm Implants

## ICX modell analog

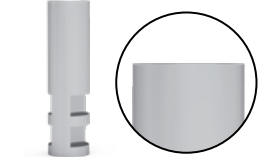
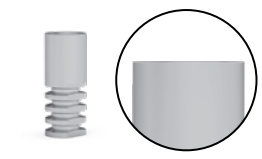
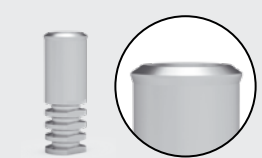
Article-No.		Article	Dimensions	Material
C-006-010001		ICX model analog for Bonelevel (BL) Implants standard	L 15mm	Titanium
C-006-010003		ICX model analog for Bonelevel (BL) Implants CAD/CAM	L 10mm	Titanium
C-006-010008		ICX model analog for TISSUE LEVEL (TL) Implants CAD/CAM	L 11.7mm	Titanium

Note: L = Length

Dear customers,

**Please note the two different platforms of the BL and TL implants. Select the BL and TL laboratory analogs accordingly.** This is important if the prosthetics later have to touch the different platforms of the implants due to the low emergence profile. different platforms of the implants (GH 0mm).

Your medentis team

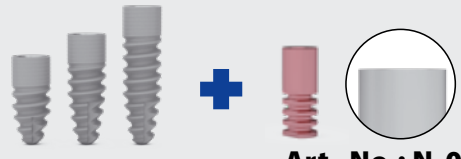

**ICX-Ø 3.3mm BL (Bone Level)**  
Ø 3.3mm  
Art.-No.: N-006-010003



**ICX-Ø 3.3mm TL (Tissue Level)**  
Ø 3.3mm  
Art.-No.: N-006-010008

# OVERVIEW: ICX-Titanium-abutments

For cemented restorations

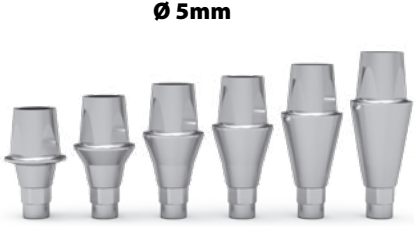
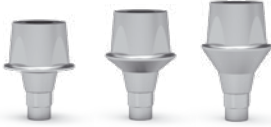
Article-No.		Article	Dimensions	Material
C-007-010501	 <p style="text-align: center;"><b>Ø 5mm</b></p>	ICX Titanium abutment, short, standard <b>Ø 5mm</b>	GH 1 mm K 4mm	Titanium
C-007-010502		ICX Titanium abutment, short, standard <b>Ø 5mm</b>	GH 2 mm K 4mm	Titanium
C-007-010503		ICX Titanium abutment, short, standard <b>Ø 5mm</b>	GH 3 mm K 4mm	Titanium
C-007-010504		ICX Titanium abutment, short, standard <b>Ø 5mm</b>	GH 4 mm K 4mm	Titanium
C-007-010505		ICX Titanium abutment, short, standard <b>Ø 5mm</b>	GH 5 mm K 4mm	Titanium
C-007-010506		ICX Titanium abutment, short, standard <b>Ø 5mm</b>	GH 6 mm K 4mm	Titanium
C-007-016501	 <p style="text-align: center;"><b>Ø 6.5mm</b></p>	ICX Titanium abutment, short, wide <b>Ø 6,5mm</b>	GH 1 mm K 4mm	Titanium
C-007-016502		ICX Titanium abutment, short, wide <b>Ø 6,5mm</b>	GH 2 mm K 4mm	Titanium
C-007-016503		ICX Titanium abutment, short, wide <b>Ø 6,5mm</b>	GH 3 mm K 4mm	Titanium



All articles C-007- incl. connection screw  
C-007-000001



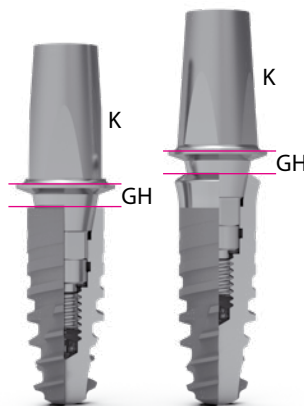

All articles on this page incl. laboratory screw  
C-007-000002

**Note:** GH = Gingiva height · K = Chimney height



# OVERVIEW: ICX-Titanium-abutments

For cemented restorations



Article-No.		Article	Dimensions	Material
C-007-020501	 <p style="text-align: center;"><b>Ø 5mm</b></p>	ICX Titanium abutment, long, standard <b>Ø 5mm</b>	GH 1 mm K 7mm	Titanium
C-007-020502		ICX Titanium abutment, long, standard <b>Ø 5mm</b>	GH 2 mm K 7mm	Titanium
C-007-020503		ICX Titanium abutment, long, standard <b>Ø 5mm</b>	GH 3 mm K 7mm	Titanium
C-007-020504		ICX Titanium abutment, long, standard <b>Ø 5mm</b>	GH 4 mm K 7mm	Titanium
C-007-020505		ICX Titanium abutment, long, standard <b>Ø 5mm</b>	GH 5 mm K 7mm	Titanium
C-007-020506		ICX Titanium abutment, long, standard <b>Ø 5mm</b>	GH 6 mm K 7mm	Titanium
C-007-026501	 <p style="text-align: center;"><b>Ø 6.5mm</b></p>	ICX Titanium abutment, long, broad <b>Ø 6.5mm</b>	GH 1 mm K 7mm	Titanium
C-007-026502		ICX Titanium abutment, long, broad <b>Ø 6.5mm</b>	GH 2 mm K 7mm	Titanium
C-007-026503		ICX Titanium abutment, long, broad <b>Ø 6.5mm</b>	GH 3 mm K 7mm	Titanium
C-007-010500	<p style="text-align: center;"><b>Only on bone level (BL) platform: tangentially tapered.</b></p>  <p style="text-align: center;"><b>Ø 3.7mm</b></p>	ICX Titanium abutment, short, Ø 3.7mm <b>Not for ICX-TL implants!</b>	<b>GH 0 mm</b> L 5mm	Titanium
C-007-020500		ICX Titanium abutment, long, Ø 3.7mm <b>Not for ICX-TL implants!</b>	<b>GH 0 mm</b> L 7mm	Titanium
C-007-030500		ICX-Titanium abutment, extralong, Ø 3.7mm <b>Not for ICX-TL implants!</b>	<b>GH 0 mm</b> L 9mm	Titanium

 All articles C-007- incl. connection screw  
C-007-000001

 All articles on this page incl. laboratory screw  
C-007-000002

# OVERVIEW: ICX-Titanium-abutments

**NOTE: All Aesthetic Titanium abutments are angled over the side surface of the Hexagonal Rotation Guard.**

Article-No.		Article	Dimensions	Material
C-010-010010	 <p>0°</p>	ICX Aesthetics Line Titanium abutment, 0°	<b>GH 1:</b> 1,0mm <b>GH 2:</b> 3,0mm K 7mm	Titanium
C-010-010030		ICX Aesthetics Line Titanium abutment, 0°	<b>GH 1:</b> 3,0mm <b>GH 2:</b> 5,0mm K 7mm	Titanium
C-010-020015	 <p>15°</p>	ICX Aesthetics Line Titanium abutment, 15°	<b>GH 1:</b> 1,5mm <b>GH 2:</b> 3,5mm K 7mm	Titanium
C-010-020025		ICX Aesthetics Line Titanium abutment, 15°	<b>GH 1:</b> 2,5mm <b>GH 2:</b> 4,5mm K 7mm	Titanium
C-010-020035		ICX Aesthetics Line Titanium abutment, 15°	<b>GH 1:</b> 3,5mm <b>GH 2:</b> 5,5mm K 7mm	Titanium
C-010-020050		ICX Aesthetics Line Titanium abutment, 15°	<b>GH 1:</b> 5,0mm <b>GH 2:</b> 7,0mm K 7mm	Titanium
C-010-040015	 <p>25°</p>	ICX Aesthetics Line Titanium abutment, 25°	<b>GH 1:</b> 1,5mm <b>GH 2:</b> 3,5mm K 7mm	Titanium
C-010-040025		ICX Aesthetics Line Titanium abutment, 25°	<b>GH 1:</b> 2,5mm <b>GH 2:</b> 4,5mm K 7mm	Titanium
C-010-040035		ICX Aesthetics Line Titanium abutment, 25°	<b>GH 1:</b> 3,5mm <b>GH 2:</b> 5,5mm K 7mm	Titanium
C-010-040050		ICX Aesthetics Line Titanium abutment, 25°	<b>GH 1:</b> 5,0mm <b>GH 2:</b> 7,0mm K 7mm	Titanium



 All articles incl. connection screw  
C-011-000001

 All articles on this page incl. laboratory screw  
C-007-000002

**Note:** GH = Gingival height - K = Chimney height - L = Length from upper implant edge

# OVERVIEW:

## ICX-Titanium-abutments (angled over surface)

Article-No.		Article	Dimensions	Material
C-010-010005	 <p><b>0°    15°    25°</b></p> <p><b>Only for ICX-TISSUE LEVEL Implants</b></p>	ICX Aesthetics Line Titanium abutment, <b>0° straight, Ø 4.5mm</b>	<b>GH 1:</b> 0.5mm <b>GH 2:</b> 1.5mm K 8mm	Titanium
C-010-020005		ICX Aesthetics Line Titanium abutment, <b>15°, Ø 4.5mm</b>	<b>GH 1:</b> 0.5mm <b>GH 2:</b> 1.5mm K 8mm	Titanium
C-010-040005		ICX Aesthetics Line Titanium abutment, <b>25°, Ø 4.5mm</b>	<b>GH 1:</b> 0.5mm <b>GH 2:</b> 1.5mm K 8mm	Titanium

**On BL platform level**



Article-No.		Article	Dimensions	Material
C-024-110005	 <p><b>0°    15°    25°</b></p> <p><b>Only for ICX-TISSUE LEVEL Implants</b></p>	ICX Aesthetics Line Titanium abutment, <b>0° straight, Ø 4.5mm</b>	<b>GH 1:</b> 0.3mm <b>GH 2:</b> 1.5mm K 8mm	Titanium
C-024-120005		ICX Aesthetics Line Titanium abutment, <b>15°, Ø 4.5mm</b>	<b>GH 1:</b> 0.3mm <b>GH 2:</b> 1.5mm K 8mm	Titanium
C-024-140005		ICX Aesthetics Line Titanium abutment, <b>25°, Ø 4.5mm</b>	<b>GH 1:</b> 0.3mm <b>GH 2:</b> 1.5mm K 8mm	Titanium

**On TL platform level**



**Note:** GH = Gingival height - K = Chimney height - L = Length from upper implant edge



All articles incl. connection screw  
C-011-000001





All articles on this page incl. laboratory screw  
C-007-000002

# OVERVIEW: ICX-Universal-abutments

## ICX-Universal-abutments (Telescope technology, customizable)

Compact, two-piece with central screw access channel

Article-No.		Article	Dimensions	Material
C-009-100001		ICX-Universal-Abutment, short, Ø 5.2mm	L 9,5mm	Titanium
C-009-100002		ICX-Universal-Abutment, long, Ø 5.2mm	L 14,5mm	Titanium
C-009-020001		ICX-Meso-Abutment Ø 7mm	L 9mm	Titanium

**Hinweis:** L = Length from implant top edge



All articles C-009- incl. connection screw C-011-000001



All articles C-009- incl. laboratory screw C-007-000002

Due to their thicker walls, the technician can grind them individually, to a responsible degree, as primary telescopes.





ICX-SHOP!



**medentis**<sup>®</sup>  
medical



# OVERVIEW: ICX bar, gold and plastic abutments

## ICX-bar-system-abutments

Article-No.		Article	Dimensions	Material
C-011-030001		Plastic abutment with hex	L 9mm K 6.3mm Ø 4.5mm	Plastic burnable
C-011-030002		Plastic abutment without hex	L 9mm K 6.3mm Ø 4.5mm	Plastic burnable
C-011-020002		Titanium abutment with hex	L 9mm K 6.3mm Ø 4.5mm	Titanium
C-011-020003		Titanium abutment long, without hex	L 13.5mm K 6.3mm Ø 4.5mm	Titanium

## ICX-TISSUE LEVEL (TL) Implant abutments

The ICX-TL abutment 0mm is only compatible with ICX-TL implants.

Artikel-Nr.		Artikel	Dimensions	Material
C-024-010501		<b>ICX-(TL)</b> implant abutment K 5mm, short, Ø 5mm	GH 0.25mm K 5mm	Titanium
C-024-020501		<b>ICX-(TL)</b> Implant abutment K 7.5mm, long, Ø 5mm	GH 0.25mm K 7.5mm	Titanium
C-024-120501		<b>ICX-(TL)</b> implant abutment K 7mm, long, Ø 5mm	GH 0mm (outer tulips Ø) K 7mm	Titanium

**Note:** K = Length of the stump from prep limit



All articles incl. connection screw  
C-007-000001



All articles incl. laboratory screw  
C-007-000002



**At inner  
TL platform level**







**At external  
TL platform level**



## OVERVIEW:

### ICX abutments/ZirkonZahn/CAD/CAM & scan body

## ICX Gold sprue and CoCr-NEM sprue technology

Artikel-Nr.		Artikel	Dimensions	Material
C-008-010001		ICX-Gold abutment (castable) Ø 5mm with hex	GH 1mm	Gold/HSL alloy Ceramicor
C-008-010002		ICX-Gold abutment (castable) Ø 5mm without hex	GH 1mm	Gold/HSL alloy Ceramicor
C-029-000022		ICX-CoCr structure (cast-on compatible with NEM), with hex	4.40 mm GH 0.5mm K 4mm	CoCr Biodur CCM/BC NEM castable (Note CTE values when firing on ceramics)
C-008-020001		ICX-CoCr abutment (cast-on compatible with NEM), with hex	Ø 4.40 mm GH 0.5mm K 4mm	CoCr Biodur CCM/BC NEM castable (Note CTE values when firing on ceramics)

## ICX plastic abutments, burn-out

Artikel-Nr.		Artikel	Dimensions	Material
C-008-030001		ICX plastic abutment Ø 5mm with hex completely burn out without residue	GH 1mm K 7mm	Plastic burnable
C-008-030002		ICX plastic abutment Ø 5mm without hex completely burn out without residue	GH 1mm K 7mm	Plastic burnable

**Note:** GH = Gingival height - K = Chimney height - L = Length from upper implant edge



All articles incl. connection screw  
C-011-000001











All articles incl. laboratory screw  
C-007-000002



## OVERVIEW:

### ICX abutments/ZirkonZahn/CAD/CAM & scan body

#### ICX CAD/CAM adhesive bases and scan bodies

Artikel-Nr.		Artikel	Dimensions	Material
C-029-000004	 <b>BL</b>	ICX adhesive base, Ø 4,4mm, with hex - <b>Only for ICX-BL</b>	<b>GH 0mm</b> K 4mm	Titanium
C-029-000005	 <b>TL</b>	ICX adhesive base, <b>Only for ICX-TL Implant</b> Ø 4,4mm with hex	<b>GH 0mm</b> K 4mm	Titanium
C-029-000002		ICX adhesive base, standard Ø 4,4mm with hex	GH 0.5mm K 4mm	Titanium
C-029-000008		ICX adhesive base, Ø 4,4mm with hex	GH 1.5mm K 4mm	Titanium
C-029-000007		ICX adhesive base, Ø 4,4mm with hex	GH 2.5mm K 4mm	Titanium
C-029-001001		ICX bar adhesive base, Ø 4,4mm without hex (for bar and bridges)	GH 0.5mm K 3.8mm	Titanium
C-030-000001		ICX scan body for model scan 1st generation	L 12mm	PEEK
C-030-000003		ICX-Scan body for intraoral scans and also for model scans 2nd generation	L 12mm	PEEK

The CAD/CAM data sets for the ICX adhesive bases are stored in the library on our medentis website:  
www.medentis.de  
There they can be requested by email for downloading.



All articles incl. connection screw  
C-011-000001



All articles incl. laboratory screw  
C-007-000002





The CAD/CAM data sets for the ICX bonding bases are stored in the library on the medentis website:  
www.medentis.de

They can be requested there by email for downloading.

## OVERVIEW:

ICX-Cerec® adhesive bases ONLY for Sirona® system

### ICX-Cerec® adhesive bases (only compatible with Sirona® system)

Article-No.		Article	Dimensions	Material
C-029-000050		ICX-Cerec® adhesive base with hex for Cerec® L block, incl. scan cap white (Bluecam),	GH 1mm K 4.65mm Ø 4.5mm	Titanium
<b>C-030-000052</b>		ICX-Cerec®- <b>Scanpost L</b> for C-029-000050 with hex incl. scan cap white (Bluecam)	GH 2.5mm K 4.65mm Ø 4.5mm	Titanium
C-029-000051		ICX-Cerec® adhesive base with hex for Cerec® L block, incl. scan cap white (Bluecam),	GH 2.5mm K 4.65mm Ø 4.5mm	Titanium
<b>C-030-000053</b>		ICX-Cerec®- <b>Scanpost L</b> for C-029-000051 with hex incl. scan cap white (Bluecam),	GH 4mm K 4.65mm Ø 4.5mm	Titanium
6431329		Scan cap, gray (Omnicam) This article is included with all Cerec® articles	-	PEEK

**Note:** GH = Gingival height - K = Chimney height - L = Length from upper implant edge



All articles incl. connection screw  
C-011-000001



All articles incl. laboratory screw  
C-007-000002

**NOTE: IN GENERAL, A SCAN VIA THE RESPECTIVE SCANPOST IS ALWAYS RECOMMENDED! THE CORRESPONDING DATA SET MUST BE SELECTED FOR SCANPOST.**

THE CORRESPONDING CAD/CAM DATA RECORD IS STORED IN THE SIRONA® SYSTEM AS DATA RECORD NB A 4.5.

### ICX E. Steger adhesive abutment ONLY for ZirkonZahn system

Article-No.		Article	Dimensions	Material
C-029-000021		ICX adhesive base for ZirkonZahn system Ø 5,1mm with hex	GH 1mm K 4mm	Titanium

**Note:** K = Length of the stump from prep limit



All articles incl. connection screw  
C-011-000001



All articles incl. laboratory screw  
C-007-000002

# CERICX®

FABRICATED, ANATOMICAL ICX ZIRCONIA ABUTMENTS

**THE PERFECT  
ECONOMIC HARMONY  
WITH CEREC®.**



CEREC® is a registered trademark of Dentsply Sirona

Combine the  
proven CERICX®-  
and Cerec® systems  
for the restoration  
of your patients.

Accuracy of fit, precision and  
the usual user-friendly application  
make this symbiosis with the aid of  
our CERICX® abutments and healing  
caps - perfect for all CEREC®  
Omnicam users.

**medentis**  
medical

**ADDED VALUE + PROFIT =  
CERICX® & CEREC®**

# OVERVIEW: CERICX-zirconium-abutments

0° degrees and 15° degrees - with optimized prep limit for intraoral scanning systems  
and Cerec® scans - in three tooth colours and 5 gingiva heights:

Each available in three tooth colours (molars only in B)

Tooth colours  
„bright“  
corresponds  
to: approx.  
A1, A2, B1



Tooth colours  
„standard“  
corresponds  
to: approx.  
A3, B2



Tooth colours  
„dark“  
corresponds to:  
approx.  
A3.5 B3

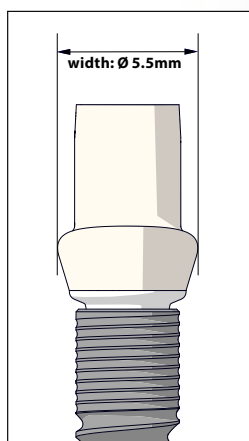
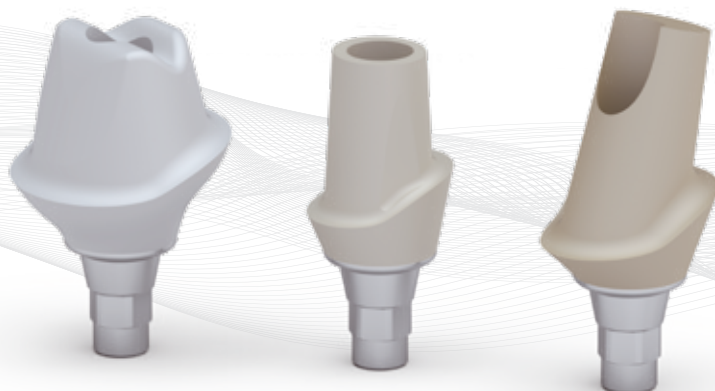

Explanation of the different dimensions,  
(Dimensions) on the basis of a CERICX example article.

Article-No.	Article	Dimensions	Material
C-036-A/B/C 10501	<b>CERICX ABUTMENT STRAIGHT 1MM</b>	Width: Ø 5.5mm Depth: Ø 5.8mm GH 1: 1.2mm GH 2: 3.1mm K: 6.5mm	Titanium/ Zirconium

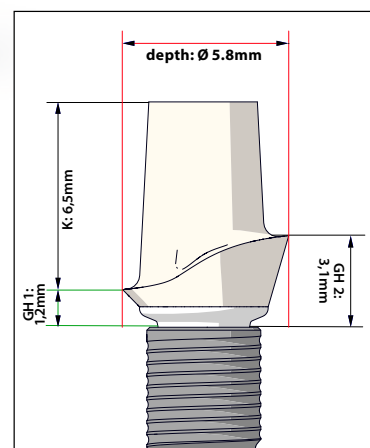

To determine the correct gingival height (GH)  
observe the associated **dimensions!**

## **B** Tooth shade „standard“

Article-No.	Article-CERICX-Molars	Dimensions	Material	B - „standard“
C-034-B 00525	CERICX abutment molar GH 2.5mm The stump and emergence profile are designed according to the molar tooth shape.	Width: Ø 9.6mm Depth: Ø 8.1mm GH 1: 3.2mm GH 2: 5.2mm K: 6.8mm	Titanium/ Zirconium	
C-034-B 00535	CERICX abutment molar GH 3.5mm The stump and emergence profile are designed according to the molar tooth shape.	Width: Ø 9.6mm Depth: Ø 8.1mm GH 1: 4.2mm GH 2: 6.2mm K: 6.8mm	Titanium/ Zirconium	

**Note:** GH = Gingival height  
K = Chimney height  
L = Length from upper implant edge









All articles incl. connection screw  
C-011-000001



All articles incl. laboratory screw  
C-007-000002

# OVERVIEW: CERICX-zirconium-abutments

## CERICX-Abutments

Article-No.	Article	Dimensions	Material	
C-036-A/B/C 10501	CERICX abutment straight 1mm	Width: Ø 5.5mm Depth: Ø 5.8mm GH 1: 1.2mm GH 2: 3.1mm K: 6.5mm	Titanium/ Zirconium	<p>A = Tooth colours „bright</p>  <p>B = Tooth colours „standard</p>  <p>C = Tooth colours „dark</p> 
C-036-A/B/C 10502	CERICX abutment straight 2mm	Width: Ø 5.5mm Depth: Ø 5.8mm GH 1: 2.2mm GH 2: 4.1mm K: 6.5mm	Titanium/ Zirconium	
C-036-A/B/C 10503	CERICX abutment straight 3mm	Width: Ø 5.5mm Depth: Ø 5.8mm GH 1: 3.2mm GH 2: 5.1mm K: 6.5mm	Titanium/ Zirconium	
C-036-A/B/C 10504	CERICX abutment straight 4mm	Width: Ø 5.5mm Depth: Ø 5.8mm GH 1: 4.2mm GH 2: 6.1mm K: 6.5mm	Titanium/ Zirconium	
C-036-A/B/C 10505	CERICX abutment straight 5mm	Width: Ø 5.5mm Depth: Ø 5.8mm GH 1: 5.2mm GH 2: 7.1mm K: 6.5mm	Titanium/ Zirconium	
C-036-A/B/C 20005	CERICX 15° Aesthetics 0.5mm	Width: Ø 5.5mm Depth: Ø 7.2mm GH 1: 1.2mm GH 2: 3.2mm K: 7mm	Titanium/ Zirconium	<p>A = Tooth colours „light</p>  <p>B = Tooth colours „standard</p>  <p>C = Tooth colours „dark</p> 
C-036-A/B/C 20015	CERICX 15° Aesthetics 1.5mm	Width: Ø 5.5mm Depth: Ø 7.2mm GH 1: 2.2mm GH 2: 4.2mm K: 7mm	Titanium/ Zirconium	
C-036-A/B/C 20025	CERICX 15° Aesthetics 2.5mm	Width: Ø 5.5mm Depth: Ø 7.2mm GH 1: 3.2mm GH 2: 5.2mm K: 7mm	Titanium/ Zirconium	
C-036-A/B/C 20035	CERICX 15° Aesthetics 3.5mm	Width: Ø 5.5mm Depth: Ø 7.2mm GH 1: 4.2mm GH 2: 6.2mm K: 7mm	Titanium/ Zirconium	
C-036-A/B/C 20045	CERICX 15° Aesthetics 4.5mm	Width: Ø 5.5mm Depth: Ø 7.2mm GH 1: 5.2mm GH 2: 7.2mm K: 7mm	Titanium/ Zirconium	

0° degree and 15° degrees - with optimized prep limit for intraoral scanning systems and Cerec® scans -. in three tooth shades and 5 gingiva heights:

**Note:** GH = Gingival height

K = Chimney height

L = Length from upper implant edge



All articles incl. connection screw  
C-011-000001





All articles incl. laboratory screw  
C-007-000002



# OVERVIEW: (angled over surface) ICX-MULTI®-Konzept = 4-ON-ICX und 6-ON-ICX

**Only for bar, bridge and splinted crown restorations -  
not suitable for single-tooth and telescopic restorations!**

Required minimum height 5.5mm

Article-No.		Article	Dimensions	Material
C-020-750000	 <b>BL</b>	<b>Only for BL!</b> ICX-multi abutmebt, straight, GH 0mm	Ø 4.8mm GH 0mm K 2.2mm	Titanium
C-020-750001	 <b>TL</b>	<b>Only for TL!</b> ICX-multi abutmebt, straight, GH 0mm	Ø 4.8mm GH 0mm K 2.2mm	Titanium





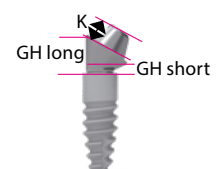
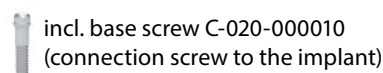
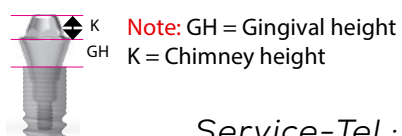







Required minimum height 5.5mm / screwdriver SW 1.2mm

Article-No.		Article	Dimensions	Material
C-020-750010		ICX-MULTI abutment, straight, one-piece	GH 1mm K 2.2mm	Titanium
C-020-750020		ICX-MULTI abutment, straight, one-piece	GH 2mm K 2.2mm	Titanium
C-020-750030		ICX-MULTI abutment, straight, one-piece	GH 3mm K 2.2mm	Titanium
C-020-750040		ICX-MULTI abutment, straight, one-piece	GH 4mm K 2.2mm	Titanium
C-020-750050		ICX-MULTI abutment, straight, one-piece	GH 5mm K 2.2mm	Titanium
C-020-751705		17° ICX-MULTI abutment, rotation-locked in implant	GH short 0.5mm GH long 1.9mm K 2.2mm	Titanium
C-020-751715		17° ICX-MULTI abutment, rotation-locked in implant	GH short 1.5mm GH long 2.9mm K 2.2mm	Titanium
C-020-751725		17° ICX-MULTI abutment, rotation-locked in implant	GH short 3.5mm GH long 4.9mm K 2.2mm	Titanium
C-020-751735		17° ICX-MULTI abutment, rotation-locked in implant	GH kurz, 3,5mm GH lang 4.9mm K 2.2mm	Titan
C-020-753505		35° ICX-MULTI abutment, rotation-locked in implant	GH short 0.5mm GH long 3.25mm K 2.2mm	Titanium
C-020-753515		35° ICX-MULTI abutment, rotation-locked in implant	GH short 1.5mm GH long 4.25mm K 2.2mm	Titanium
C-020-753525		35° ICX-MULTI abutment, rotation-locked in implant	GH short 3.5mm GH long 6.25mm K 2.2mm	Titanium
C-020-753535		35° ICX-multi abutment, rotation-locked in implant	GH short 3.5mm GH long 6.25mm K 2.2mm	Titanium



# OVERVIEW: (angled over surface) ICX-MULTI®-Konzept = 4-ON-ICX und 6-ON-ICX

Required minimum construction height is 5.5mm



Article-No.		Article	Dimensions	Material
C-003-000005		ICX-MULTI Protection cap	Ø 4.8 L 4.6mm	Titanium
C-005-070001		ICX-MULTI impression posts, closed, incl. impression cap	L 11mm	Titanium
C-005-070002		ICX-MULTI impression posts, open, short incl. impression aid	L 13mm	Titanium
C-005-070020		ICX-MULTI impression posts, open, long incl. impression aid	L 16.7mm	Titanium
C-006-010007		ICX-MULTI Model analog CAD/CAM	L 11mm K 2,.mm	Titanium
C-020-951120		ICX-MULTI Prosthetic abutment, Titanium	Ø 4.8 L 12mm (shortenable to 4.1mm)	Titanium
C-020-952120		ICX-MULTI Prosthetic abutment, Plastic	Ø 4.8 L 12mm (shortenable to 4.1mm)	Plastic burnable
C-020-953120		ICX-MULTI Prosthetic abutment PEEK (PROVISIONAL/BITE REGISTRATION)	Ø 4.8 L 12mm (shortenable to 4.1mm)	Peek
C-029-002010		ICX-MULTI adhesive base (for bars and resin veneer bridges)	Ø 4.8 L 5.5mm	Titanium
C-029-002011		ICX-MULTI adhesive base GH 0mm, (for ceramic veneer bridges)	Ø 5.4mm, L 5.5mm	Titanium
C-030-000010		ICX-MULTI Scan cap	L 12.5mm B 4.5mm T 6.5mm	Peek
C-030-000013		ICX Multi Scan base narrow	Ø 4.10mm L 10mm	Titanium
C-031-100001		ICX-Maximus cap, GH 3mm, (additionally to GH ICX-multi abutment)	Ø 4.8 L 4.4mm	Titanium



incl. prosthetic screw C-020-000011 (connection screw to ICX-MULTI abutment)

## OVERVIEW:



# ICX-MULTI®-Concept = 4-ON-ICX and 6-ON-ICX

Article-No.		Article	Dimensions	Material
C-020-956120		ICX-MULTI prosthetic abutment CoCr Biodur CCM/BC NEM cast-on	Ø 4.8mm L 7mm	CoCr Biodur CCM/ BC
C-020-955120		ICX-MULTI welding abutment 1st generation for welding of several abutments with the aid of a titanium wire	Ø 4.8mm L 12mm	Titanium
C-020-955121		ICX-MULTI welding abutment 2nd generation for welding of several abutments with the aid of a titanium wire	Ø 5.1mm L 10.5mm	Titanium

 incl. prosthetic screw C-020-000011  
(connection screw for the ICX-MULTI abutment)



### Field of application and indication

The ICX-MULTI® concept is a prosthetic concept for immediate restoration of edentulous patients. For better support of the subsequent restoration, it is possible for the posterior implants to be placed at a 17° or 35° angle distally. This angulation is compensated by the special abutments.

Article-No.	Article	Dimensions	Material	
C-015-100030	ICX-MULTI Hex tool SW 1.2mm medium	SW 1.2mm	Stainless steel	
C-020-000001	ICX-MULTI insertion tool SW 3,2mm for straight multi abutments <b>Mandatory!</b>	SW 3.2mm	Stainless steel	

## ICX-MULTI abutments without rotation lock to the implant.

Additional angling over edge possible. **DISCONTINUED ARTICLE!**

Article-No.		Article	Dimensions	Material
C-020-851715		17° ICX-MULTI abutment, not rotation-locked in implant	GH short 1.5mm GH long 2.9mm K 2.2mm	Titanium
C-020-851735		17° ICX-MULTI abutment, not rotation-locked in implant	GH short 3.5mm GH long 4.9mm K 2.2mm	Titanium
C-020-853505		35° ICX-MULTI abutment, not rotation-locked in implant	GH short 0.5mm GH long 3.25mm K 2.2mm	Titanium
C-020-853515		35° ICX-MULTI abutment, not rotation-locked in implant	GH short 1.5mm GH long 4.25mm K 2.2mm	Titanium
C-020-853535		35° ICX-MULTI abutment, not rotation-locked in implant	GH short 3.5mm GH long 6.25mm K 2.2mm	Titanium



# ICX-IMPLANTS PROVIDE YOU RELIABILITY.



FOR HAPPY DENTISTS  
AND HAPPY PATIENTS.

## THAT'S ICX!

FAIR AND SUCCESSFUL. FOR MORE THAN 17 YEARS.

TOP-SERVICE FOR ICX CUSTOMERS -  
RIGHT FROM THE START.

# OVERVIEW: ICX-t-bona ball head system

Patrices

Artikel-Nr.		Artikel	Dimensionen	Material
C-022-060001		ICX-t-bona ball head abutment, Ball Ø 2.25mm	GH 1mm	Titanium
C-022-060002		ICX-t-bona ball head abutment, Ball Ø 2.25mm	GH 2mm	Titanium
C-022-060003		ICX-t-bona ball head abutment, Ball Ø 2.25mm	GH 3mm	Titanium
C-022-060004		ICX-t-bona ball head abutment, Ball Ø 2.25mm	GH 4mm	Titanium
C-015-100007		ICX-t-bona ball head Insertion tool	L 19mm	Stainless steel

**Note:** GH = Gingival height

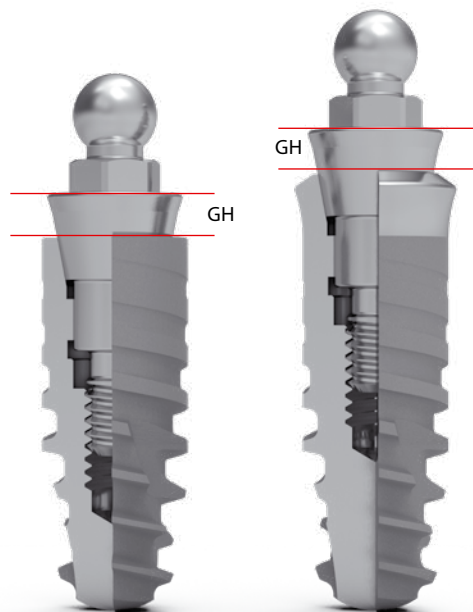









ICX-SHOP!





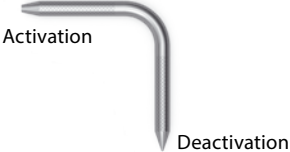

# OVERVIEW: ICX-t-bona ball head system

## t-ecco/Matrice

Article-No.		Article	Material
T-13825		t-ecco, matrice, complete, incl. golden inner matrice, red plastic auxiliary ring and model analog	Titanium plus AuPt
T-13836		t-ecco, matrice, single <b>without golden inner matrice</b>	Titanium
T-13833		t-ecco, golden inner matrice	AuPt
T-13846		t-ecco, golden color inner matrice (weak)	Titanium Grad5
T-13845		t-ecco, red inner matrice (strong)	Titanium Grad5
EK-833100		Model analog	Messing
T-10571		t-ecco-activator/deactivator	Stainless steel
960002		Hex tool, SW 0.9 short, L 20mm	Stainless steel
C-015-100029		Hex tool, SW 0.9 long, one-piece L 35mm	Stainless steel

## Dalbo®-PLUS/Matrice

Article-No.		Article	Material
DP-055890		Dalbo PLUS Female TE set elliptical Complete incl. Dalbo PLUS lamella insert	Titanium plus Elitor
DP-055643		Dalbo PLUS lamella insert (without groove marking)	Elitor
DP-050068		Dalbo PLUS Tuning soft lamella insert (1 indentation) for ball head abrasion up to 0.05mm	Elitor
DP-055687		Dalbo PLUS Tuning lamella insert (2 indentation) for ball head abrasion from 0,05mm	Elitor
DP-072609		Dalbo PLUS tool/activator (per 1/4 turn increases the trigger force by 200g)	Stainless steel

**Note:** Please be sure to use the Dalbo-PLUS tool (DP-072609) to adjust the retention individually according to the situation.

# OVERVIEW: ICX Maximus abutments, classic one-piece

## Patrices

### Please note:

With an exact gingival height of e.g. 1mm, an additional distance of 0.5mm remains between the occlusal gingiva and the lower edge of the matrix restoration.



## ICX Maximus abutment, classic-compact one-piece

These patrices are turned in.

Article-No.		Article	Dimensions	Material
C-031-020001		ICX Maximus abutment, classic one-piece	GH 1mm	Titanium
C-031-020002		ICX Maximus abutment, classic one-piece	GH 2mm	Titanium
C-031-020003		ICX Maximus abutment, classic one-piece	GH 3mm	Titanium
C-031-020004		ICX Maximus abutment, classic one-piece	GH 4mm	Titanium

The one-piece & two-piece ICX Maximus abutments are a proprietary further development of medentis medical, compatible with the Locator™ abutments. Available for all ICX implants!

**Note:** GH = gingival height

C-015-100018		Triangular turning tool 25mm (short)	Stainless steel
C-015-100031		Triangular turning tool 30mm (long)	Stainless steel

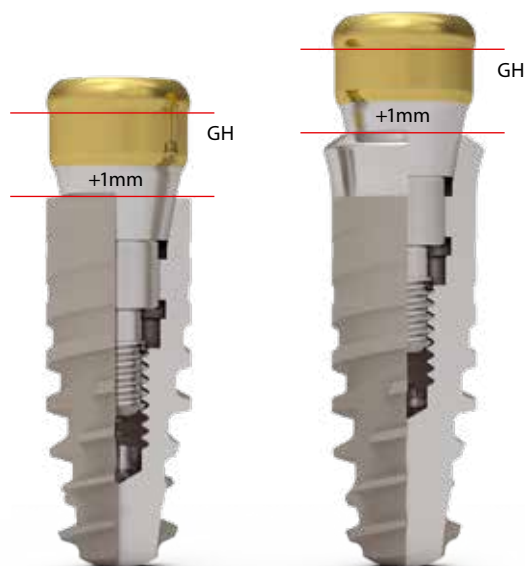

# OVERVIEW: ICX Maximus abutments, two-piece

## ICX Maximus abutment, one-piece

Male with screw access channel & connection screw.

These anti-rotation superstructures are plugged and screwed.

Article-No.		Article	Dimensions	Material
C-031-010001		ICX Maximus abutment, with hex, two-part incl. connection screw	GH 1mm	Titanium
C-031-010002		ICX Maximus abutment, with hex, two-part incl. connection screw	GH 2mm	Titanium
C-031-010003		ICX Maximus abutment, with hex, two-part incl. connection screw	GH 3mm	Titanium
C-031-010004		ICX-Maximus-Aufbau, with hex, two-part incl. connection screw	GH 4mm	Titanium
C-031-010005		ICX Maximus abutment, with hex, two-part incl. connection screw	GH 5mm	Titanium

The one-piece & two-piece ICX Maximus abutments are a proprietary further development of medentis medical, compatible with the Locator™ abutments. Available for all ICX implants!

**Note: It is inserted with 1.4mm hexagon insertion tool**

Article incl. connection screw

 C-031-000001

C-031-000001		ICX-Maximus Connection screw	Titanium Grad 5
--------------	---	------------------------------	-----------------

Siehe Seite 61		ICX hex tool SW 1,4mm	Stainless steel
----------------	---	-----------------------	-----------------











ICX-SHOP!



# OVERVIEW: ICX Maximus Accessories

## Matrices

### ICX Maximus Accessories:





Article-No.		Article	Material
C-031-851902		Processing package (titanium cap with black laboratory insert, spacer ring and retention inserts)	Titanium/ Plastic (pack of 2)
C-031-851910		Processing package (titanium cap with black laboratory insert, spacer ring and retention inserts)	Titanium/ Plastic (pack of 10)
C-031-009142		Matrice	Titanium
C-031-851500		Processing maleblack, no retention (laboratory)	Plastic (pack of 4)
C-031-852400		Retention insert transparent Pull-off force approx. 2.3 kg, strong divergence compensation $\pm 10^\circ$	Plastic (pack of 4)
C-031-852700		Retention insert pink Trigger force approx. 1.6 kg, medium divergence compensation $\pm 10^\circ$	Plastic (pack of 4)
C-031-852900		Retention insert blue Pull-off force approx. 0.7 kg, weak divergence compensation $\pm 10^\circ$	Plastic (pack of 4)
C-031-854700		Retention insert green Pull-off force approx. 1.8 kg, medium divergence compensation $\pm 20$	Plastic (pack of 4)
C-031-854800		Retention insert red Pull-off force approx. 0.4 kg, weak divergence compensation $\pm 20$	Plastic (pack of 4)
C-031-852300		ICX-Maximus Block out Spacer, 2er Pack	Plastic (pack of 2)



# OVERVIEW: ICX Maximus Accessories

## Matrices

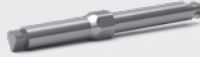
### ICX Maximus Accessories:

Article-No.		Article	Material
C-015-100032		Core Tool (general purpose tool)	Stainless steel
C-031-850501		Impression cap	Titanium (pack of 4)
C-031-853000		Model analog 04mm	Titanium (pack of 4)
C-015-100018		Triangular turning tool 25mm (short)	Stainless steel
C-015-100031		Triangular turning tool 30mm (long)	Stainless steel

Visit our ICX-Shop.



# OVERVIEW: ICX Instruments Box

## ICX Instruments Box

Pos. no.	Quantity	Article no.	Description
1	1	C-018-000104	ICX Instrument Box (empty)
1	1	C-018-000105	ICX Instrument Box (filled)
2	1	C-015-100007	ICX t-bona insertion instrument, ISO shaft
3	1	C-021-000002	Square key ISO shaft
4	1	960004	Drill extension
5	1	C-020-000001	Multi Insertion Tool ISO-Shaft
6	1	C-015-100031	Maximus Insertion Tool ISO Shank
7	1	950099	Screwdriver ISO-Shaft
8	1	C-015-100033	Screwdriver ISO-Shaft
9	1	960002	Screwdriver ISO-Shaft
10	1	C-015-100029	Screwdriver
11	1	C-015-100030	Screwdriver
12	1	C-015-100025	Screwdriver
13	1	C-015-100005	ICX Body puller
14	1	DP-072609	Dalbo PLUS tool/activator
15	1	960001	Torque ratchet
16	1	C-015-100009	ICX Mini Counter Tool
17	1	960007	Universal ratchet adapter
18	1	T-10571	t-ecco activator/deactivator

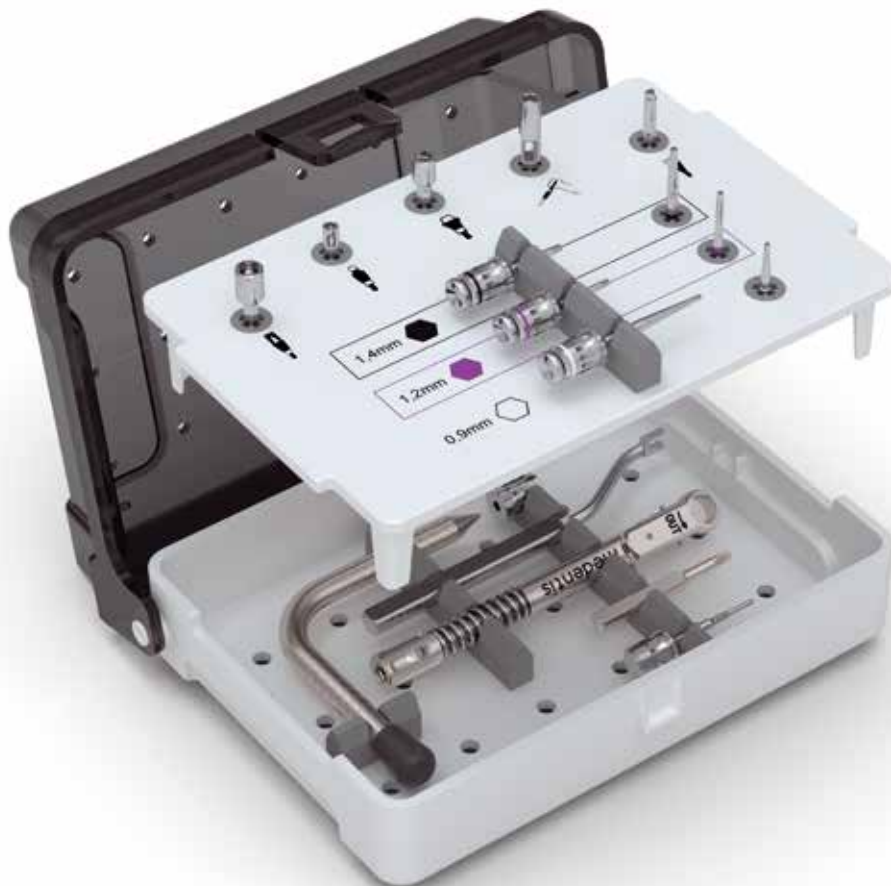



# OVERVIEW: ICX-Try-in-Box

## ICX-Try-in-Box





Pos. no.	Quantity	Article no.	Description
1	1	C-018-030001	ICX-Try-in-Box



**medentis**  
medical













## ICX implant insertion instruments

Article-No.		Article	Material
C-015-100006		ICX insertion tool, For all ICX-MINI implants Ø 2.9mm	Stainless steel
C-021-000002		ICX placement tool / For all WHITE ceramic implants & solid abutments	Stainless steel
C-015-100001		ICX insertion tool (ISO shaft) L 23mm, short For all ICX implants: Ø 3.45/3.75/4.1/4.8	Stainless steel
C-015-100002		ICX insertion tool (ISO shaft) L 29mm, medium For all ICX implants: Ø 3.45/3.75/4.1/4.8	Stainless steel
C-015-100004		ICX insertion tool (ISO shaft) L 40mm, long For all ICX implants: Ø 3.45/3.75/4.1/4.8	Stainless steel
C-015-100021		ICX insertion tool, L 30mm, one-piece, medium For all ICX implants: Ø 3.45/3.75/4.1/4.8	Stainless steel
C-015-100040		ICX insertion tool, (ISO shaft) lockable, L 30mm The innovative click system allows easy and safe removal of the of the ICX implants.	Stainless steel
C-015-100035		ICX insertion tool, lockable, L 31mm The innovative click system allows easy and safe removal of the of the ICX implants.	Stainless steel

Article-No.		Article	Material
C-015-100000		ICX Insertion tool with screw connection	
C-015-110000		ICX insertion tool narrow with screw connection	
C-015-100000 und C-015-110000		<b>In the set (* *valid until revoked): 1 x ICX insertion tool with screw connection and 1 x ICX insertion instrument narrow</b>	— Sets
2 x C-015-100000		<b>In the set (* *valid until revoked): 2 x ICX insertion tool with screw connection</b>	— Sets
2 x C-015-110000		<b>In the set (* *valid until revoked): 2 x ICX insertion tool narrow with screw connection</b>	— Sets

# OVERVIEW: ICX Accessories

## ICX hexagonal instruments (screwdrivers)

Article-No.		Article	Material
950099		ICX hex tool (ISO shaft) SW 1.4mm medium, L 24mm for all screws of the abutments, as well as healing caps	Stainless steel
950098		ICX hex tool (ISO shaft) SW 1.4mm long, L 28mm for all screws of the abutments, as well as healing caps	Stainless steel
950097		ICX hex tool (ISO shaft) SW 1.4 mm extra long, L 45mm for all screws of the abutments as well as healing caps	Stainless steel
C-015-100023		ICX hex tool (one-piece) SW 1.4mm, short, L 21mm	Stainless steel
C-015-100025		ICX hex tool (one-piece) SW 1,4mm, medium, L 27mm for all abutment screws	Stainless steel
C-015-100024		ICX hex tool (one-piece) SW 1.4mm, long, L 31mm	Stainless steel
<b>Only for ICX-3.3mm and MULTI system</b>			
C-015-100033		ICX hex tool (ISO shank) SW 1.2mm, L 25mm	Stainless steel
C-015-100043		ICX hexagonal instrument (one-piece) SW 1.2mm, short, L 23mm	Stainless steel
C-015-100030		ICX hex tool (one-piece) SW 1.2mm, medium, L 27mm	Stainless steel
C-015-100036		ICX hex tool (one-piece) SW 1.2mm, L 32mm	Stainless steel
<b>Only for ICX-2.9mm screw plugs and t-ecco matrix inserts</b>			
960002		ICX hex tool (ISO shaft) SW 0.9mm, L 20mm for t-ecco inner matrice and ICX-MINI cover screw	Stainless steel
C-015-100029		ICX hex tool (one-piece) SW 0.9mm, L 38.5mm for t-ecco inner matrice and ICX-MINI cover screw	Stainless steel
Article-No.		Article	Material
960007		ICX ratchet adapter for all instruments with ISO shaft connection	

**Note: All torque ratchets from any manufacturer with an ISO shaft adapter can be combined with our ISO shaft instruments.**

# RECOMMENDED VALUES FOR TORQUES



5 Ncm to 10 Ncm (hand-tight)	
Screw plugs	
Gingiva former	
Impression posts	
Plastic abutments	

# RECOMMENDED VALUES FOR TORQUES



max. 15 Ncm

Scan body  
and all  
other abutments  
made of PEEK



# RECOMMENDED VALUES FOR TORQUES



<b>max. 30 Ncm</b>	
all titanium abutments	
Adhesive bases	
CERICX	
Ball head	
Maximus	
ICX-multi abutments	<p style="text-align: right;"><b>(occlusal screw connection with 15 Ncm)</b></p>

# RECOMMENDED VALUES FOR TORQUES



## ICX-Implants

### General insertion:

Not less than  
15Ncm  
and not more than  
55Ncm.

### Immediate loading:

Not less than  
35Ncm

### ICX-ACTIVE MASTER -Implants

In the  
interforaminal area  
no more than  
40Ncm

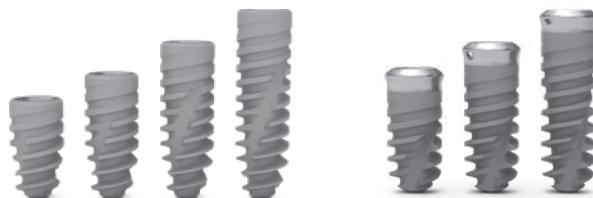
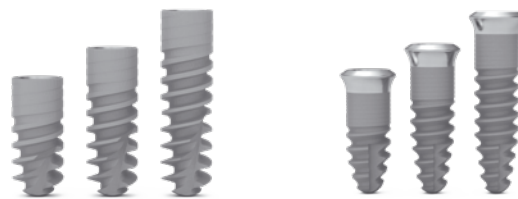

# ICX-PRODUCT INFO

## ICX-BL + TL Implants



ICX-Ø 3,3mm **BL** (Bone Level)  
Ø 3,3mm

Art.-Nr.: N-006-010003



ICX-Ø 3,3mm **TL** (Tissue Level)  
Ø 3,3mm

Art.-Nr.: N-006-010008



ICX-**BL** (Bone Level)  
Ø 3,75 · Ø 4,1 · Ø 4,8mm

Art.-Nr.: C-006-010001

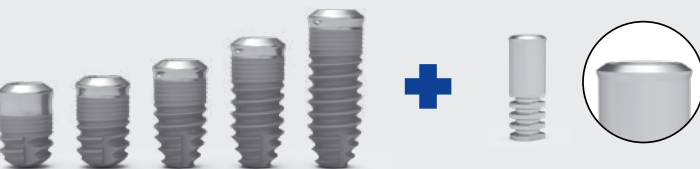

ICX-**TL** (Tissue Level)  
Ø 3,45 · Ø 3,75 · Ø 4,1 · Ø 4,8mm

Art.-Nr.: C-006-010008

Dear customers,

Please note the two different platforms of the BL and TL implants during transfer.

Select the BL and TL laboratory analogs accordingly.

This is important if the prosthetics must later touch the different platforms of the implants due to the low emergence profile (GH 0mm).



*Welcome to  
the successful ones!*



**SIMPLY ONE OF THE BEST.**  
**IN QUALITY & PRICE.**

ICX-SHOP!



**BE SMART. BE ICX.**







# ICX

DAS FAIRE  
PREMIUM  
IMPLANTAT-  
SYSTEM.

April\_2024\_EN

## ICX-PRODUKTKATALOG

04/2024



# ICX.

*Simply one of the Best!  
In Quality & Price.*

mm02627

medentis medical GmbH

Walporzheimer Str. 48-52 · 53474 Bad Neuenahr/Ahrweiler · Germany · Tel.: +49 (0)2641 9110-0

[www.medentis.de](http://www.medentis.de)

BE SMART. BE GUIDED. BE ICX.

**medentis**  
medical